

ALTERNATIVES TO GROWTH PROMOTERS

**Brendan Lynch,
Teagasc, Moorepark**

Introduction

In pig production, the terms "growth promoter", "performance enhancer", and "digestive enhancer" include a diverse range of products ranging from simple chemicals (copper salts) to chemically produced antibacterial compounds (carbadox) to antibiotics (tylosin, avilamycin, salinomycin, virginiamycin). Most of the antibiotic group are produced during a fermentation process by yeasts, moulds, and other microorganisms and have been used in pig production for over 40 years. Newer "performance enhancer" products include probiotics, enzymes, metal chelates, bacterial cultures, and complex sugars.

Use of antibiotics in disease treatment (therapeutic use) involves high dosages for a short period, given by injection or orally in water, or less often, given in feed. Sometimes, antibiotics are fed at lower levels to prevent disease at critical times in the animal's life, such as weaning, transport, mixing (prophylactic use).

Since about 1950, it has been recognized that low levels (growth-promotion or sub-therapeutic use) of some antibiotics fed continuously would improve feed intake, growth rate, and feed conversion efficiency of several farm species. The inclusion levels used (typically 10-50 ppm) are well below the amount used in disease control (100-200), and the medical profession has argued for a long time that such use promotes development of microbial resistance, which could compromise the effectiveness of antibiotics in human medicine. However, only a few products have been used for growth promotion during the past several years, and these have been products with no role in human medicine, and little or no role in animal medicine. In addition, these antibiotics (when used according to licence) are active in the gut only, are not absorbed, and do not leave residues in milk, meat, or eggs.

Resistance to antibiotics is a serious medical problem, and an upsurge in food-related illness, e.g. salmonellosis and E. Coli 0157 has focussed attention on antibiotic use in animals and food as a source of resistant bacteria. While it is recognized that liberal usage of antibiotics in human medicine is the main problem, other factors have also been blamed. Two major concerns of the medical profession are that resistant bacteria, especially salmonella from animals, might infect humans, and also that resistance to particular antibiotics in bacteria in farm animals might be transferred to other pathogenic bacteria in humans, making human pathogens resistant to related antibiotics, e.g. recent development of a new antibiotic for human use, which is related to virginiamycin (used as a growth promoter in animals for 20 years).

Much of the debate may be un-informed, but nonetheless consumers are appalled at the idea that farmers should be permitted to feed antibiotics to animals in order to make them grow faster and more efficiently, and the use of growth promoters is now a serious public-relations problem for the meat animal industry. In practice, the consumer (through cheaper food) may be the principal beneficiary of performance enhancers (de Craene and Viane, 1992), but consumers are also frightened by stories of drug residues in meat, BSE, salmonella, GMOs. In the face of a hostile, sensationalist media, sensationalist politicians and media-friendly activists who are antagonistic to animal farming, efforts to explain to consumers that the legal use of antibiotic growth-promoters which have substantial safety dossiers, and result in no residue in meat, poses no health risk, seem doomed to failure.

In Denmark, the use of growth-promoters, in feeds for pigs after 35 kg liveweight, is prohibited by a voluntary code (accompanied by random on-farm feed-sampling) and a tax on the products (Kjeldsen and Pedersen, 1999). From January 1, 2000, use of growth-promoters in starter feeds will cease. Records to-date on diarrhoea and health on 61 farms suggests that about 10% of farms have problems, about 30% have had temporary problems (lasting 1-2 months), and 60% have had no adverse effect of feeding without growth-promoters. Compliance is considered good, and of 200 farms whose feed was sampled, only one farm was found to be in violation of the code.

Last year, the EU decided to ban the use, at growth-promotion level, of four of the most widely-used antibiotic growth-promoter products. These were tylosin (Tylamix - used for growing pigs), virginiamycin (Stafac - used in growing pigs and sows), zinc bacitracin (Albac - used for growing pigs) and spiramycin (Spira - used for growing pigs, but not in the UK and Ireland). Olaquinox and carbadox, which have been widely used in Ireland in starter feeds, were banned in a separate decision for being hazardous to mill-operatives. While veterinary use (under prescription) of some of these products for disease-treatment may still be permitted, it is likely that manufacturers will cease to market at least some of the formulations.

For the present, in Ireland and other EU countries, some antibiotics may still be legally used in pig feeds, e.g. avilamycin (Maxus), salinomycin (Salocin), and flavophospholipol (Flavomycin). When fed at the permitted inclusion-levels, these products may be used up to slaughter without a withdrawal-period. However, it is likely that the current EU ban will be extended, over the next few years, to cover all products with antibiotic activity. For environmental reasons, the ban may even extend to the use of high levels of copper sulphate and zinc oxide.

How Effective are Antibiotic Growth-Promoters ?

The effectiveness of growth-promoters in pig production has been well established over the past 40 years. In general, the biggest responses are found in younger pigs (Table 1), and in less hygienic conditions, or where the health status on the unit is poorer (Table 2). Standards of hygiene in pig units in Ireland are extremely high, with washing and all-in-all-out systems being the norm in weaner units and becoming more common in finisher units. As a result, we would expect responses, i.e. improvements in growth-rate and FCE at the present time to be less than was achieved in the past.

From an early stage, concern has been expressed that prolonged usage might result in poorer responses as a result of development of bacterial resistance. US experience shows that the magnitude of responses has been maintained over time, despite the presence of some resistant microorganisms.

Table 1. Responses of pigs to antibiotic growth-promoters in feeds (% improvement over control)

Category of Pig	Growth Rate	Feed Intake	FCE
Starter	16	8	7
Weaner	11	5	5
Finisher	4	2	2

Based on 1,200 trials on 32,000 pigs. Adapted from Cromwell, 1991

Table 2. Effect of age of pig health status on response of finishing pigs to growth-promoters in feed (% improvement over control)

Health Status	Trait	None	Added	Improvement
Low	Daily gain	686	735	7%
High	Daily gain	845	858	2%
Low	FCE	3.12	2.90	7%
High	FCE	2.75	2.67	3%

Stahly et al., 1994

Consequences of the Ban for Pig Producers in Ireland

In the short-term, feed manufacturers will switch to the permitted antibacterial growth-promoters, with little effect on pig performance. A full ban on routine inclusion of antibacterial growth-promoters in creep and starter feeds could seriously affect post-weaning health and performance. In Sweden, where in-feed use of growth-promoters has been banned since 1986, there has been a reduction in the overall tonnage of antibiotics used, but an increase in the amounts of some of the more potent products, and an increase in usage of prescription medication (Mudd et al., 1998). Other accounts from Sweden are less pessimistic, claiming that while the main effects of the ban were reduced post-weaning gain, and more diarrhoea, there has been little adverse economic effect (Goransson, 1997). This is because of changes to feed formulations (less protein, more fibre), restricted feeding for the first 7-10 days, use of zinc oxide, and more attention to hygiene, housing, and environment.

What are the Non-Antibiotic Alternitives ?

The next few years will see a wide range of alternative products coming on the market here. Table 3 shows a range of products, which are already available. Many will have in-house or farm trial data to substantiate their claims, but most will have little or no independently-verified trial work.

Producers (and, more especially, feed company nutritionists) should be sceptical of all claims and insist on at least two or three independent, sizeable, and statistically-analyzed, performance-trials with relevant costings. Some of the more important categories of product are described below.

Table 3. Non-antibiotic growth-promoters for pigs)

Category	Examples
<i>Enzymes</i>	<i>Phytase; proteases; cellulase</i>
<i>Metal chelates</i>	<i>Organic iron; organic copper; bioplexes; organic chromium</i>
<i>Probiotics and bacterial cultures</i>	<i>Lactobacilli; fermented feeds</i>
<i>Acids and acid salts</i>	<i>Citric acid; fumaric acid; acid salts and blends</i>
<i>Complex carbohydrates</i>	<i>Mannanologosaccharides; fibre extracts</i>
<i>Botanicals</i>	<i>Garlic</i>
<i>Miscellaneous substances</i>	<i>Immunostimulators; zeolites; essential oils</i>

Enzymes

The use of enzymes to improve digestibility of feed is well established in poultry nutrition. Addition of beta-glucanase has allowed the widespread use of barley in poultry feeds, without previous problems of wet litter. With the exception of phytase, which is very effective in improving digestibility of phosphorus in cereals and oil-seeds, experience with addition of enzymes to pig feeds has been mixed. Sometimes, sizeable responses are found, but often no improvements have been recorded. Stability of enzymes, during the exposure to heat in pelleting of feeds is a concern. It is often difficult to assay enzymes to determine if the material was added, the strength of the addition, and whether it remains viable. Wet feed systems are favourable to enzyme activity, but would need heating, and a soaking period.

Metal Chelates and Organic Mineral Sources

These are special sources of minerals, which are more efficiently absorbed by the animal than the ordinary salts, such as ferrous sulphate, copper sulphate, etc. Chelates are far more expensive per unit of mineral than the alternative materials, and at present have little to recommend them. Limitations on copper and zinc inclusions may make chelates more attractive.

Probiotics and Bacterial Cultures

In theory, feeding cultures of "desirable bacteria" to animals could result in the pathogens being "crowded out". Many probiotic products on the market have low levels of viable bacteria. Pelleting is likely to significantly reduce the numbers present, and whether they survive in the pig and colonize the digestive tract, is also doubtful. Fermentation of wet feed is a form of probiotic use, in that growth of lactobacilli is encouraged.

Organic Acids

Several organic acids, salts of organic acids, and acid-salt blends, have been used in pig feeding trials, especially with weaners. Our experience at Moorepark is that acids improve performance of weaned pigs fed low-quality diets. Where high-density diets, high in milk powders, have been used, the response to acid addition has been much less. In Denmark, acids have been used to reduce diet pH, and either kill Salmonella in feed, or stop its proliferation. The same logic is used to justify fermenting wet feed and is supported by a lower reported-incidence of salmonella in farms in Denmark where wet feeding is used.

Acids have sometimes been recommended as part of a salmonella-control programme in Ireland on pig units, with a high proportion of salmonella-positive animals at slaughter. On its own, it is difficult to see feed acidification as playing more than a minor role unless the more important elements of a control programme, such as cleaning, pig flow, segregation by age, are in place.

Complex Carbohydrates

These products are claimed to benefit animal performance in one of two ways: their presence may prevent pathogenic bacteria adhering to the gut-wall, and also by reaching the hind-gut of the animal in an undigested form, they may influence the pattern of hind-gut fermentation towards more desirable bacteria. At the recommended inclusion-levels of less than 1% in the diet, it is difficult to see these products having a significant effect on gut fermentation of healthy pigs. Beet-pulp in the diet will have a similar effect. Digestion of feed in the hind-gut is wasteful of feed-energy, so the FCE implications of complex carbohydrates must be considered.

Costs Versus Benefits

All inclusions in feed add to the cost and the return in improved growth-rate, FCE, or pig health must exceed that extra cost for the inclusion to be justified. A product adding 1.5 to 2% (approximately £2.00-£3.00 per tonne) to feed costs, necessitates an improvement in FCE of finishers of about 0.06 units, e.g. from 2.80 to 2.74. The monetary equivalent is about 60p per pig, or 1p per kg carcass.

Conclusions

The antibiotic-type growth-promoting agents, used in the past, have been beneficial to pig production and to the consumer through cheaper food, but have now become a public-relations problem for the industry. Future use of these products in growing-pigs will have to be reconsidered.

References

- Cromwell, G.L. (1991). *Anti-microbial agents. In: Swine Nutrition (Eds. E.R. Miller, D.E. Ullrey and A.J. Lewis), Butterworth-Heinemann, Boston. pp.297-314.*
- de Craene, A. and Viane, J. (1992). *Economic effects of technology in agriculture : do performance-enhancers for animals benefit consumers ? University of Ghent. 143pp.*
- Goransson, L. (1997). *Alternatives to antibiotics - the influence of new feeding strategies for pigs on biology and performance. In: Recent Advances in Animal Nutrition (Eds. P.C. Garnsworthy and J. Wiseman), Nottingham University Press, Nottingham. pp.45-56.*
- Kjeldsen, N. and Pedersen, A.O. (1999). *Experiences of the voluntary ban of growth-promoters for pigs in Denmark. Paper presented to the 50th Annual Meeting of the European Association for Animal Production, Zurich, Switzerland.*
- Mudd, A.J., Lawrence, K. and Walton, J. (1998). *Study of Sweden's model on anti-microbial use shows usage has increased since 1986 ban. Feedstuffs. October 26, p.1.*
- Stahly, T.S., Williams, H. and Zimmerman, D.R. (1994). *Impact of carbadox on rate and efficiency of lean tissue accretion in pigs with low or high immune system activation. Journal of Animal Science, 72 (Supp. 1): 84.*

DRY SOW HOUSING - THE NORTHERN IRELAND EXPERIENCE

**Liz Donnelly and Mark Hawe,
Greenmount College, Northern Ireland**

Introduction

*On 1st January, 1999, the 'Welfare of Pigs' Regulations (Northern Ireland) 1991' came into force. This legislation was introduced in September 1991, and banned the installation of **new** stall and tether systems from 1st October, 1991. The legislation, however, allowed for a phasing-out period for **existing systems**; this phasing-out period expired on 1st January, this year. This means in practice that in the United Kingdom all dry sows now have to be loose housed. In addition to the legislation requirements from the marketplace have also demanded a move towards loose housing. This has had major implications for the Northern Ireland pig industry.*

Individual Confinement

The individual confinement of sows was originally introduced for welfare reasons. Individual confinement allows for sows to be fed as individuals, and prevents aggression, especially at feeding-time. Timid sows and sows in poor condition can receive their fair share of feed, without being bullied. Sows are relatively easy to manage, and observation and treatment of individuals is excellent.

However, the pig industry has done a full-circle in that cubicles and tethers have now been banned, as they are not considered to be welfare-friendly. Research has shown that sows that are confined perform abnormal types of behaviours, including bar-biting, sham chewing, head-weaving, and drinker-pressing for 10-50% of daylight hours (Jensen, 1988; Broom et al., 1995). Also, sows in cubicles are active for only 12% of daylight hours, compared to 56% in an environment where they are loose, and have a substrate to manipulate (Broom, 1986; Wood-Gush et al., 1990).

Legislation

The United Kingdom legislation states that any pigs, including pregnant sows, shall not be kept in a pen or stall on agricultural land, unless:

- (a) It is free at all times to turn around, without difficulty*
 - (b) The area of the pen or stall is not less than the square of the length of the pig;*
- and*
- (c) Every side of the pen or stall has a length which is not less than 75% of the length of the pig.*

This has had major implications for the Northern Ireland pig industry, as the majority of sows were individually confined.

A survey carried out by the Ulster Farmers' Union, in October 1995, indicated that 70% of producers housed their sows in cubicles, with 8% in tethers. A survey conducted by Teagasc, in 1997, showed that, in the Republic of Ireland, 59% of dry-sows and served-gilts were tethered, 30% were in stalls, and 11% were loose.

Choice of System

There are several loose-housing-systems available for dry-sows, all of which are designed around a particular method of feeding. At the outset, it is important to state that there is no one system which can be described as the ideal. Each has its merits and drawbacks, and it is important, before choosing a system, that these are clearly understood. The choice is, to a large extent, based on individual preference, and the importance which a producer puts on certain requirements, for example, ability to readily observe sows, need to individually feed sows, ability to easily identify and remove sows, flexibility of system, level of training required, and ability to provide bedding.

LOOSE HOUSING IN NORTHERN IRELAND

The main loose-housing systems in operation in Northern Ireland can be categorized under two headings, depending on whether the sows are kept in dynamic or static groups.

Systems Based on Dynamic Groups

Electronic Sow Feeding (ESF) - Traditional Layout

Electronic Sow Feeding (ESF) - Two-Yard Layout

Dump/Spin Feeding

Systems Based on Static Groups

Voluntary Cubicles

Kennels with Individual Feeders

Dump Feeding

Trickle Feeding

Individual Pens

Converted Cubicles

Electronic Sow Feeding - Traditional Layout

In Northern Ireland, in the late-80's and early-90's, ESF was the most commonly chosen system. However, by the mid-90's, it's popularity had declined. This was due, in the main, to the high levels of aggression and vulva-biting experienced on some units, and the unreliability of equipment. However, as experience has been gained in the manufacture of the equipment, and, more importantly, in the layout and design of houses, these problems, although still present, have been reduced. ESF is now given serious consideration by producers in Northern Ireland, especially the larger units with the primary advantage of individual feeding of sows being the main 'selling' point.

ESF allows for automatic individual feeding of sows in groups. Each sow is identified by a transponder in an ear-tag. The sow enters the feed-station through a rear-gate, and is fed for a pre-set amount of feed, depending on her stage of pregnancy, and

body condition. Feed allocation is computer-controlled, with individual feed scales being entered onto the computer. The computer also allows for the identification of sows which have not eaten any feed, or sows which have not eaten their full amount.

With traditional ESF, a specialized training area is required to allow new sows, entering the system for the first time, to become familiar with the operation of the feed station. Sows are trained by manually assisting them through the feed station. An important feature of this system is the capture facility. Sows, which are due to farrow, due for vaccination or pregnancy-testing, are automatically shed from the feed station into a capture pen. They can then be moved into the farrowing house, vaccinated or pregnancy-tested, and returned to the main group.

ESF is based on dynamic groups ranging from 60 up to 200, with the larger groups perhaps split into two or three sub-groups. As already stated, although much has been learnt about the layout of houses, position of feeders and drinkers, and the space-requirements, over the past 8-10 years, there is no consensus as to what is the ideal layout, with different manufacturers having their own views. Plan 1 shows a layout, which has been successfully used, on a Northern Ireland unit for the last 2 years. It is based on a dynamic group of 90 sows, with two feed stations providing adequate feeding and training facilities.

Electronic Sow Feeding - Two-Yard Layout

The two-yard layout was developed in Northern Ireland in the mid-90's, and is a system which has been, and will continue to be, popular. The two-yard layout is basically a variation on the traditional layout, and, as the name implies, the house is split into two-yards (entry and exit yards), or more simply, into two areas each containing a lying and dunging/roaming area. A feed station is positioned in the partition dividing the two areas, and as the sows feed, they automatically move from one yard to the other. The sows cannot return to the entry-yard until they are let into this area by the stockperson opening a gate at the start of the next feed cycle. This operation is carried out early in the morning, with most sows having fed by late-afternoon. Towards the end of the feeding cycle, a few sows remain in the entry-yard. These are normally ones which are unfamiliar with the system, timid, or off-colour.

Plan 2 shows a typical layout of a two-yard ESF house in Northern Ireland.

Experience in Northern Ireland would suggest that, in general, levels of aggression are less with the two-yard layout, and that management of the sows is easier than with the traditional system. This is, in the main, due to less reliance on the computer to identify sows which are off-colour, and the fact that timid sows can feed in their own time.

Dump/Spin Feeding

The dump feeders are usually suspended at a height of 1.5m to 1.8m, with the feed automatically dispensed onto the floor with a radius of 1.5m. Each feeder feeds up to 8 sows. The amount of feed dispensed can be adjusted, depending on the number of sows in the group.

Spin Feeding

With spin feeding, the feed is spread over a large area, ranging from 6m to 24m. Experience has shown that the feed is distributed very evenly over the area, theoretically giving all sows equal access to feed. The spin feeder is usually positioned with the spin plate no lower than 2m from the ground. Typical model capacities are 145kg, 180kg, and 280kg.

A typical layout for spin feeding is illustrated in Plan 3.

Voluntary Cubicles

Voluntary cubicles have been the most popular alternative system of housing in Northern Ireland. This is a simple and reliable system, based on small groups of sows. It has the potential to allow sows to be fed individually. Voluntary cubicles suit almost any size of unit, with the group size varying, depending on the number of sows weaned per batch. Typical group size is 4, although it can vary from 3 to 6. With voluntary cubicles, the sows use the cubicle as a lying and feeding area, with the dunging/roaming area normally slatted, and the slats extending into the cubicle by 0.6m to 0.9m.

A common layout for voluntary cubicles is illustrated in Plan 4.

Kennels with Individual Feeders

This is a simple, reliable, and relatively easy-to-manage, system, again based on small static groups of sows. It has proven to be a popular system in Northern Ireland. As with the voluntary cubicles, group size ranges from 4 to 6, with 4 being typical. This system is similar to voluntary cubicles, with a kennel positioned behind the roaming-area, and all within a naturally-ventilated general-purpose-type umbrella-building.

Plan 5 shows a plan of a house in Northern Ireland which is operating very successfully. It accommodates 312 sows in three rows of kennels.

Work carried out by Walker and Beattie (1994) at the Agricultural Research Institute of Northern Ireland has shown that if sows are given the choice of sleeping-area which includes a communal-area, individual un-gated stalls and sow-operated-stalls, they will spend 13% of their time in the un-gated stall, 13% in the stalls with-gates, and 74% lying as a group. This indicates that whilst some sows prefer to lie as individuals, others prefer to lie as part of a group. Kennels with individual feeders, to an extent, offers sows the choice of lying as individuals or as part of a group.

Trickle Feeding

In Northern Ireland, a few producers have opted for trickle feeding. With trickle feeding, the sows are accommodated in loose pens, incorporating the required number of shoulder-length feed-stalls (0.45-0.6m long). At feeding time, the feed is dispensed very slowly into the sow's trough, usually at a rate of 100-120g/minute. The rate is set to accommodate the speed of the slower-feeding sows. The principle behind trickle feeding is that because the feed is dropped at a slow rate, this encourages the sows to remain in their feeding places. However, in practice, on the few units in Northern Ireland where trickle feeding has been installed, swapping of places, and, hence, aggression, has been a problem, particularly at the start and end of the feeding period. However, it must be emphasized that experience of trickle feeding in Northern Ireland is very limited, with only a small number of systems in operation.

The problems experienced on commercial farms have also been seen at the Agricultural Research Institute of Northern Ireland, Hillsborough, where research by Walker and Beattie (1994) has shown that there was a high level of place-swapping (either voluntarily or because of aggression), queuing behind a feeding-sow, and poaching of feed, when sows were fed in short cubicles (1.0m), with trickle feeding (Figure 1).

One of the first trickle feeding systems to be installed in Northern Ireland is illustrated in Plan 6.

Individual Pens

A very small number of producers in Northern Ireland have built new dry-sow houses, based on individual loose pens. It was felt in these cases that the mixing of sows would be detrimental to their welfare, and the only successful way to house sows was individually. Typically, the individual pens constructed were 2.4m x 1.5m, and, in one house, which is illustrated in Plan 7, the sows were provided with a solid lying area, which is scraped-out automatically twice a day. The sows also have access to straw, in a wire basket, at the front of each pen. As the floor has a slight slope, this allows for the straw to move down the pen to the scraped area at the back.

Converted Cubicles

With the introduction of a price-differential of 10p/kg in October 1998, considerable pressure was put on producers to loose-house their sows. As this introduction coincided with the worst crisis ever to hit the pig industry, producers obviously had to look for low-cost options of loose-housing. For many, this involved reducing the overall length of the existing cubicles, and giving the sows access to either the central or rear passages. The part of the cubicle, which was cut-off, was then used to make a gate to sub-divide the sows into small groups (usually 4). In some houses, to make it easier for moving the sows in and out of the house, one cubicle per batch was made front-opening.

To enable producers to meet legislation, and to try to ensure as accurate a feed rationing as was practical, producers had to settle for a compromise-situation. This

involved leaving enough space behind the sow (at least the length of the sow), and, at the same time, leaving as long a feed cubicle as possible. It had been shown, from research at Hillsborough, that cubicle length has a major influence on feed rationing. Studies have indicated that the longer the cubicle, the higher the proportion of sows which are able to consume the correct amount of feed (Table 1).

Table 1. Feed consumption of sows given feed in un-gated cubicles of varying length

	Cubicle length (m)		
	2.0	1.0	0.5
% of sows eating exact ration	77	60	40
Number of withdrawals per sow during feeding	0.76	1.01	3.43

In practice, in most cases, an 0.9m to 1.2m-long cubicle was left, and, as a result, place-swapping at feeding time is common, leading to variable sow condition, and increased aggression. Another practical problem which has been experienced has been that of dirty pens, as, in many cases, the passages were originally solid. The effect of this on sow fertility is yet to be determined.

Subjective Assessment

An overall subjective assessment of the different loose-housing systems in operation in Northern Ireland is provided in Table 2.

Table 2. Summary of subjective assessment of loose-housing systems

	ESF Traditional Layout	ESF 2-Yard Layout	Spin Feeding	Dump Feeding (Dynamic Group)	Voluntary Cubicles	Kennels and Feeders	Trickle Feeding	Individual Pens	Converted Cubicles
Level of aggression (Feeding Time)	***	*	****	****	**	**	***	*	****
Individual rationing	*	*	***	****	**	**	***	*	***
Observation of sows	****	****	****	****	**	***	***	*	***
Individual identification within group	****	****	****	****	**	**	**	*	**
Isolation/removal of sows	*	*	****	****	**	**	**	*	**
Cost	***	***	*	**	***	****	***	****	*

*
**

Best
↓
Worst

Mixing of Sows

Anybody involved in pig production is only too aware that sows are naturally aggressive animals, and fighting occurs when sows from unfamiliar sources are mixed. Practical experience in Northern Ireland has shown that mixing of sows in large mixing-pens or yards can help reduce the amount of fighting. Currently, MAFF recommends 3.5m²/sow for mixing areas. It has been shown, that in cubicle-systems, sows will use the cubicle as an escape-area, and this can also help to reduce the number of injuries at mixing.

It is a generally-held belief that a solid-floor mixing-area, with straw, is desirable over a slatted-pen. However, work at Hillsborough has shown that mixing sows in solid-floored pens, bedded with straw, did not reduce aggression, compared with mixing in slatted-floor pens. Both types of pens had 2m-long cubicles, which provided escape-areas for the sows. Fight-damage, which was assessed subjectively on a 1-5 scale, with the aid of photographic records, was 1.69 on slats and 2.00 on solid-floors, indicating significantly more damage in solid-floor pens. This may be due to the sows being more reluctant to prolong conflicts on the slats due to the less-sure footing (Walker & Beattie, 1994).

Further work at Hillsborough has also shown that forming small groups of sows (4) at weaning, and leaving them together for 5 weeks, reduces the level of aggression when the sows are introduced into a large dynamic group (Table 3) (Durrell et al., 1999).

Table 3. Behaviour of sows in a dynamic group, having entered the group as individuals at weaning, or as a small group

<i>Behaviour (% time)</i>	<i>Introduced as individuals</i>	<i>Introduced as small group</i>
<i>Lying in contact with other sows</i>	29.1	37.3
<i>Locomotion</i>	4.2	3.0
<i>Nose to body contact</i>	0.4	0.9
<i>Attacking or being-attacked</i>	0.10	0.01
<i>Fighting</i>	0.31	0.02

Also, housing sub-groups next-door to the main-group for a period of time, can help to reduce the duration of fighting.

In addition to the welfare-benefits to be gained from delaying the introduction of sows into a dynamic group on farms, trials in Denmark have also shown that improved breeding herd performance can be obtained (Table 4).

Table 4. Transfer strategy for loose group-fed sows

Transfer into loose-housing	After weaning	After pregnancy-test
Litters produced	686	666
Total* number of births	11.8	12.4
Farrowing percentage	83.6	83.7

*Born alive + born dead

This has also been borne-out by practical experience in Northern Ireland, where, although some producers can 'get away' with introducing sows into the main group immediately after service, repeats are normally higher in sows introduced at this stage. It is generally recommended that for dynamic groups, new sows are not introduced until at least 4 weeks post-service.

Commitment

It is obvious from this paper that there is no one type of loose-housing which 'stands out' as being "the ideal system". Each has its merits and drawbacks. Experience in Northern Ireland has shown that the overall success of a system depends, to a larger extent, on the level of commitment and determination of the person managing the system.

If a producer is totally committed to the system, and is determined to make it work, then there is a much higher chance that it will be a success. A half-hearted approach will give half-hearted results.

References

- Broom, D. M. (1986). *Responsiveness of stall-housed sows. Applied Animal Behaviour Science, 15, 186.*
- Broom, D. M., Mendl, M. T. and Zanella, A. J. (1995). *A comparison of the welfare of sows in different housing conditions. Animal Science, 61, 369-383.*
- Durrell, J., Beattie, V. E. and Sneddon, I. A. (1999). *Effects of pre-mixing sows prior to their introduction into a larger dynamic group: sow behaviour and welfare. Proceedings of the British Society of Animal Science, p. 183.*
- Jensen, P. (1988). *Diurnal rhythm of bar biting in relation to other behaviour in pregnant sows. Applied Animal Behaviour Science, 21, 337-346.*
- Pig Health Society. *Proceedings of the 27th Annual Symposium 1999. Pig production in Ireland – Planning for the future.*
- UFU (1995). *Stalls and tethers survey.*
- The National Committee for Pig Breeding. *Health and Production Annual Report 1995.*
- Walker, N. and Beattie, V. E. (1994). *Welfare of sows in loose housed systems. 67th Annual Report, Agricultural Research Institute of Northern Ireland, pp 21-28.*
- Wood-Gush, D. E. M., Jensen, P. and Algers, B. (1990). *Behaviour of pigs in a novel semi natural environment. Biology of Behaviour, 15, 62-73.*

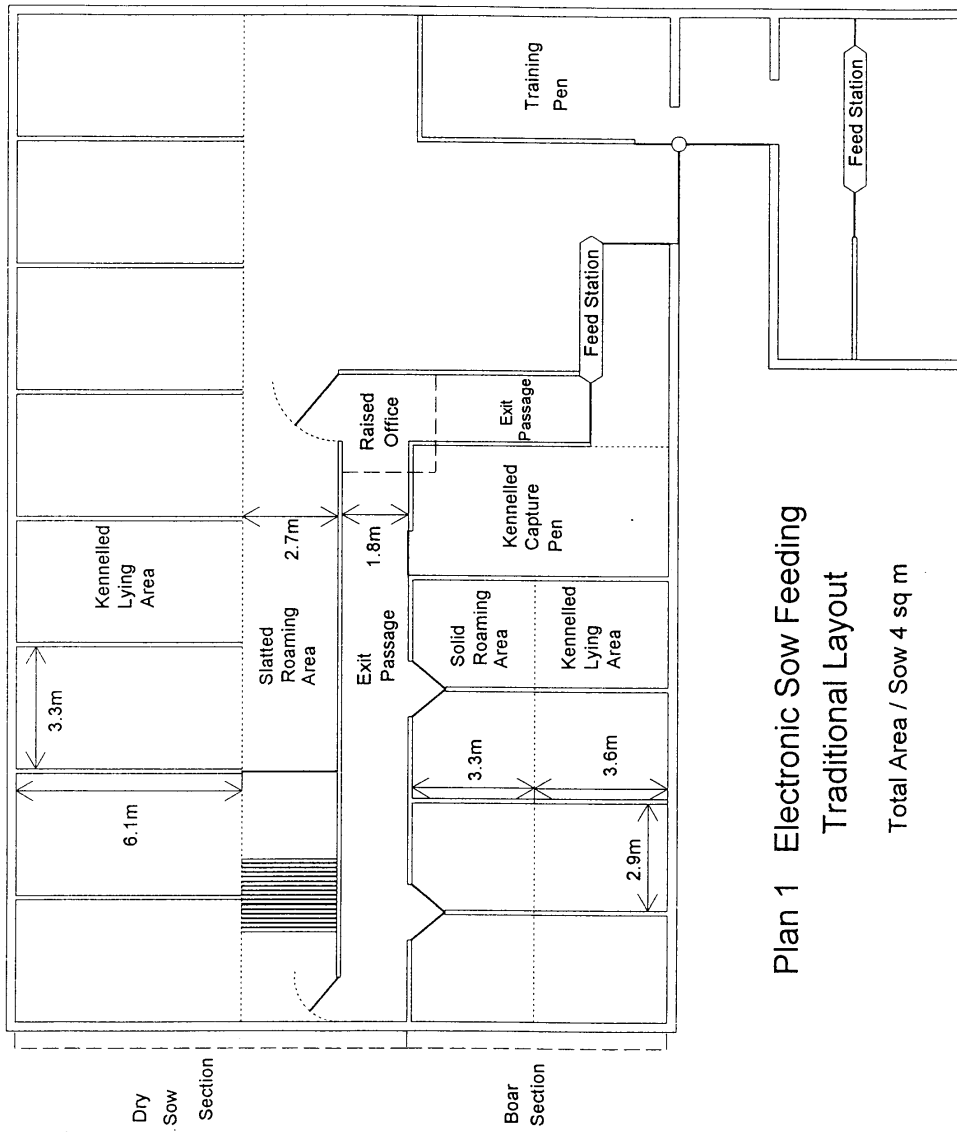

Plan 1 Electronic Sow Feeding
Traditional Layout

Total Area / Sow 4 sq m

Plan 2 Electronic Sow Feeding - Two Yard Layout

Total Area /Sow 3sq m

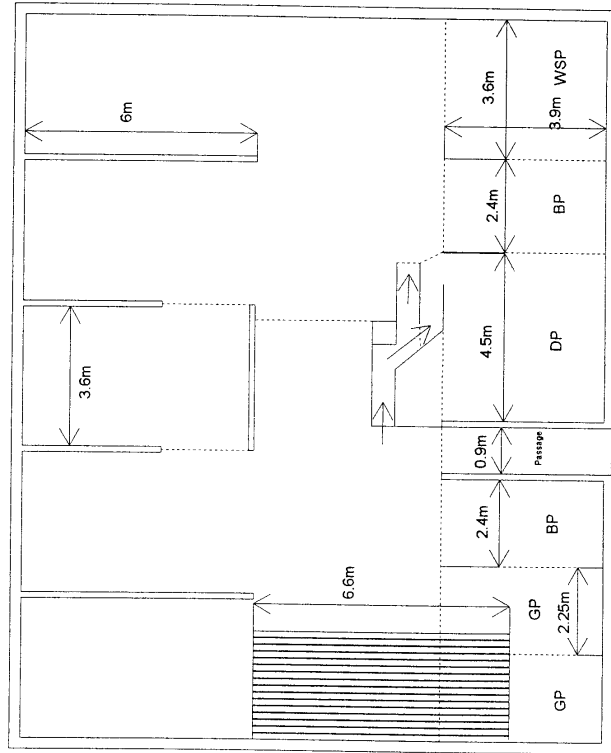

Kennelled Lying Area

Slatted Roaming/Dunging Area

Loose Pens

- GP Gilt Pen
- BP Boar Pen
- DP Diver Pen
- WSP Weaned Sow Pen

Plan 3 Spin Feeding

Total area / Sow 2.27 sqm

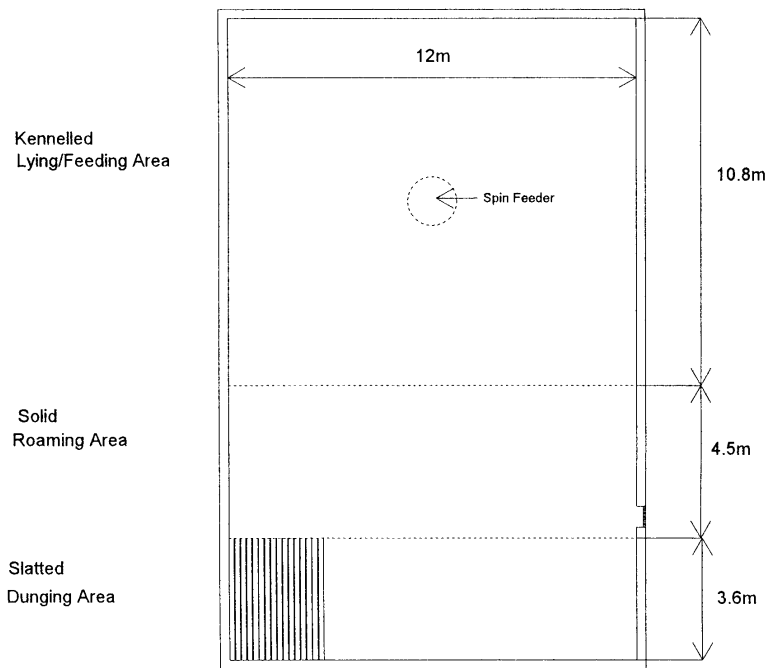

Plan 4 Voluntary Cubicles
Total Area / Sow - 2.7 sq m

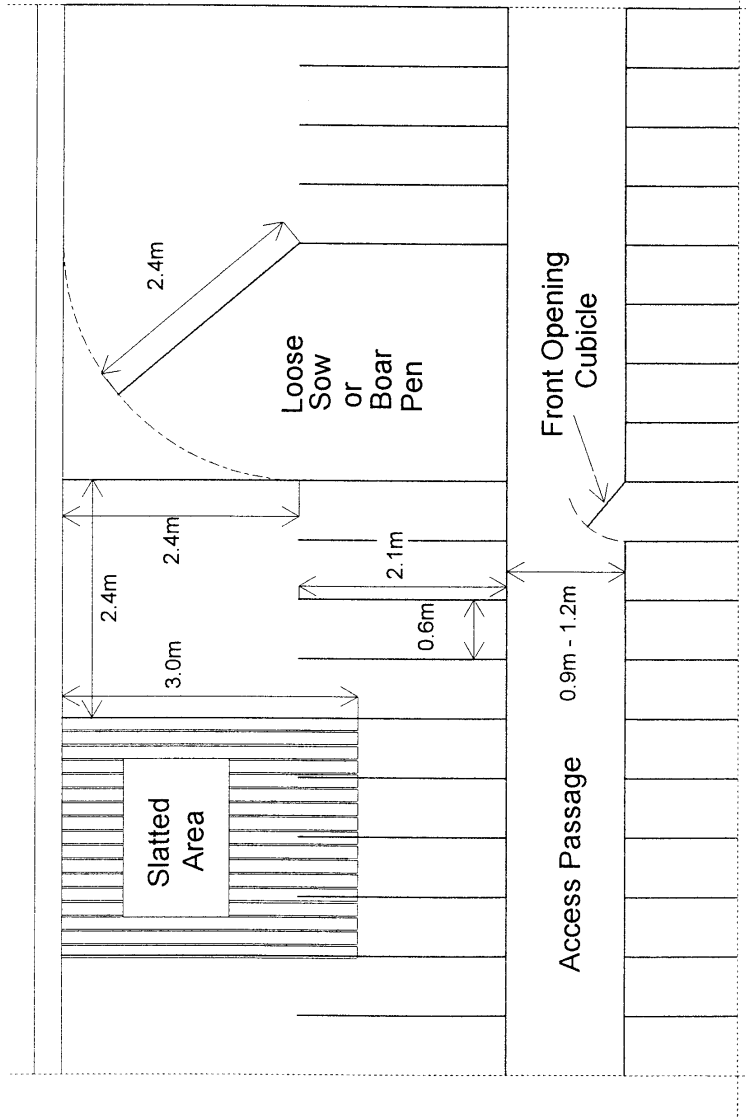

Plan 5 Kennels with Individual Feeders

Total Area / Sow - 3.3 sq m

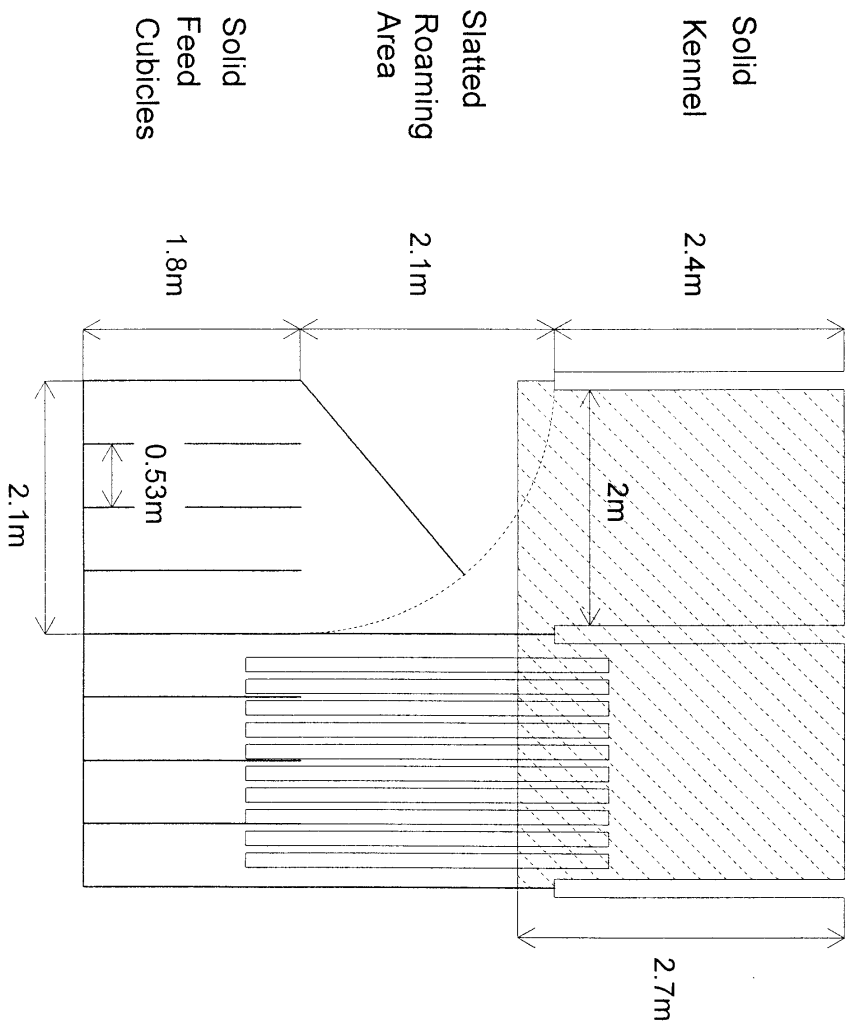

Plan 6 Trickle Feeding

Total Area / Sow - 3.4 sq m

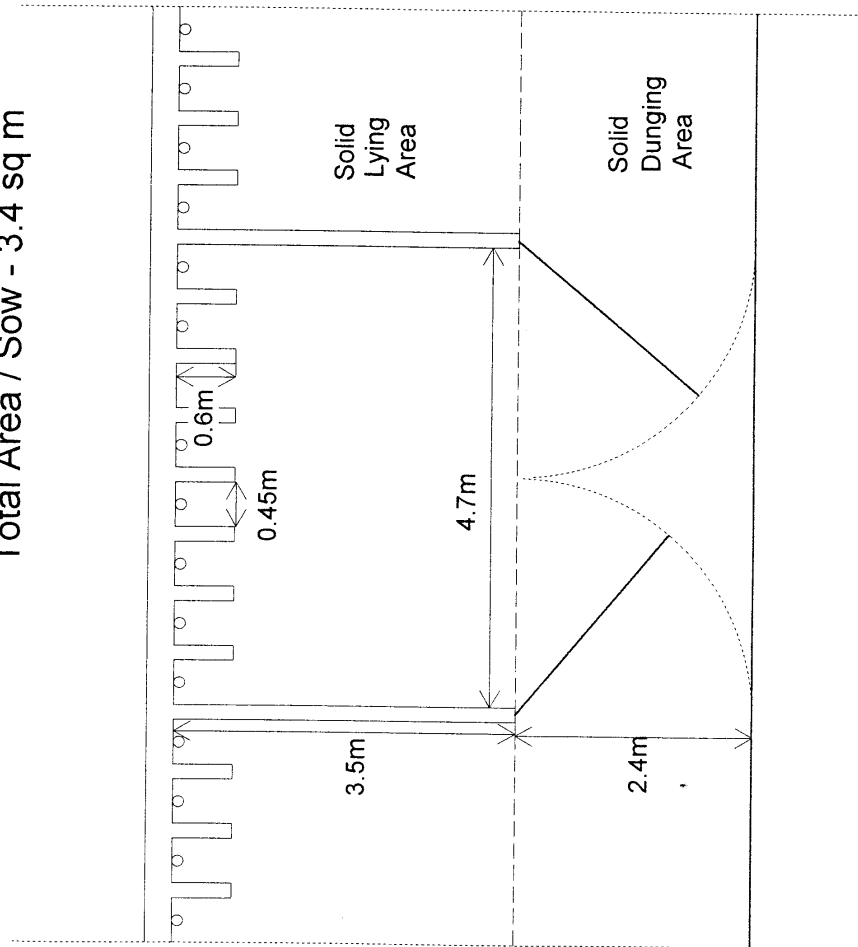

Plan 7 Individual Pens

Total Area / Sow 3.6 sq m

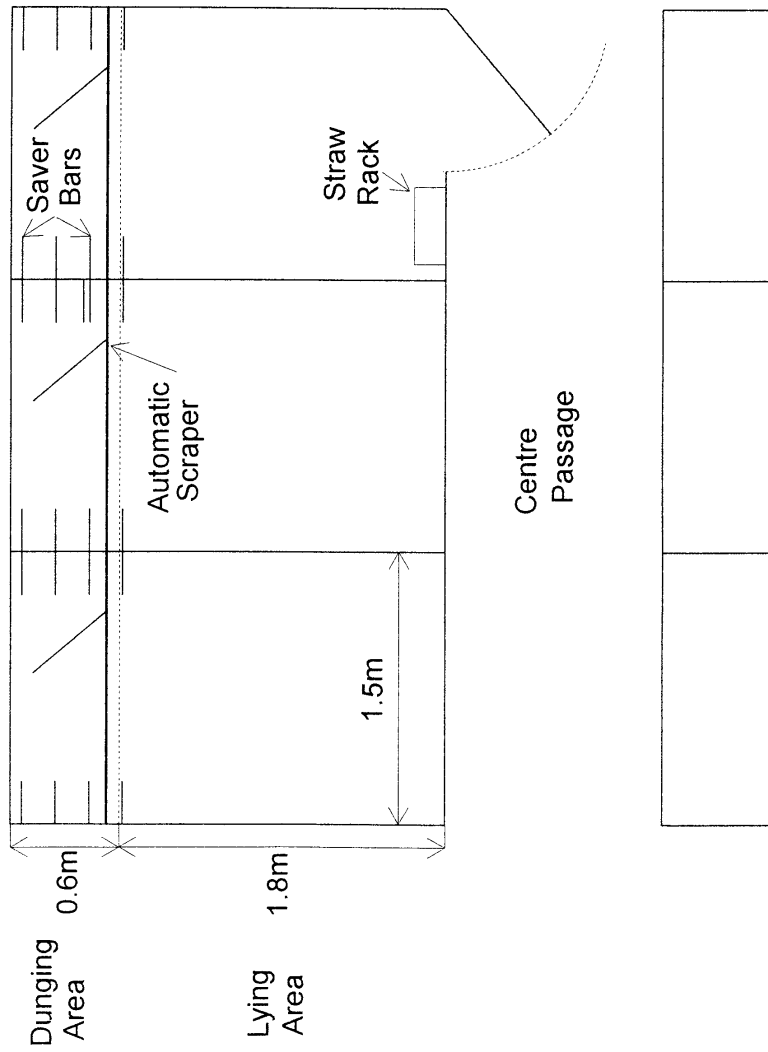

BEHAVIOUR OF LOOSE-HOUSED SOWS

**Laura Boyle and Annabel Tergny,
Teagasc, Moorepark**

Introduction

One of the main criticisms of intensive housing systems is that the animals have little opportunity to perform social behaviour. This is one reason for the current unpopularity of stall and tether systems for pregnant sows. In contrast, housing in groups offers social companionship. However, the damage that sows in groups can inflict on each other gives rise to other welfare concerns.

Studies on wild pigs show that sows are actually very social animals, living in small groups, and sleeping in communal nests. These groups have a degree of flexibility in their social organization, with females being fairly tolerant of the gradual integration of new members. However, sows will not tolerate the sudden introduction of unfamiliar individuals in a confined space, and this gives rise to the severe aggressive encounters observed after mixing. Even after a dominance-hierarchy has formed, aggression can still occur, over access to food, drinkers, or even preferred lying areas. However, some loose systems allow more social harmony than others, and in these cases the potential exists for sow welfare to be better than in stalls or tethers.

Effects of Group Size and Space Allowance

Aggression amongst loose sows varies according to pen layout (Edwards, 1992), group size (Hartsock and Curtis, 1983), and space allowance (Jensen, 1984; Weng et al., 1998). These factors were examined in an experiment which assessed two pen designs of potential interest to farmers who are considering converting existing stall or tether houses (Figure 1). Multiparous sows were housed in groups of 4 and 8, in fully-slatted pens, with full-length, ungated feeding stalls (= free access stalls), from 3 to 5-weeks post-service, for a one-month trial period. In total, eight batches of sows in each group size were observed.

The sows had been kept in stalls in previous pregnancies, and from the mating prior to the trial, and were returned to stalls after the trial ended. The space allowance in groups of four was 2.8m² (30ft²)/sow, and 2.0m² (22ft²)/sow in groups of eight. The layout with eight sows represented a possible conversion option in a house currently holding two rows of stalls (though wider than most such houses), while that with four sows represented a design which has been used in a number of new installations in Ireland.

Figure 1. Pen designs (drawings not to scale)

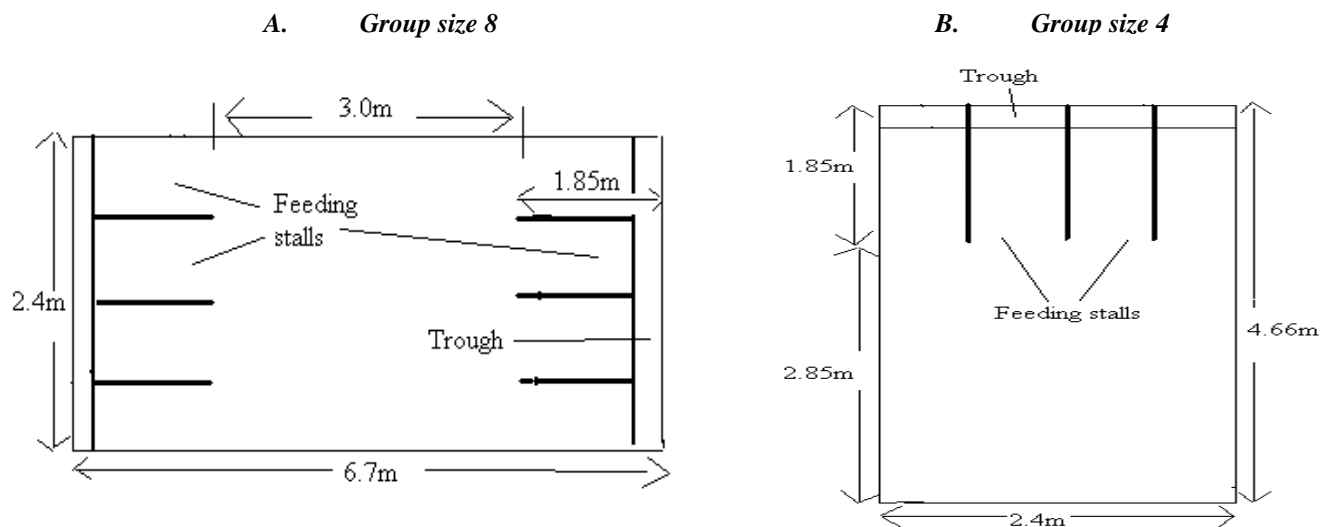

1. Mixing

There are suggestions that it is better to mix sows on slatted floors than on solid floors, as sows are reluctant to prolong conflicts with the less sure footing which slats provide (Walker and Beattie, 1994). However, fighting on slats can lead to serious foot injuries, and in some cases, the necessity to cull injured sows. For this reason, the slatted common area in the pens used in our trial was covered with rubber mats (R.J. Mooney & Sons, Ltd., Longmile Road, Dublin) for the first 24-hours after mixing. The mats did appear to offer some protection to the sows while the dominance hierarchy was being established, as only one sow, out of a total of 96 which were housed in groups, was removed for lameness. However, this effect must be qualified experimentally. None of the sows repeated during the trial period.

2. Aggression

Neither the frequency, nor the severity, of fights differed between sows in groups of four or eight, on the day of mixing, or throughout the housing period. However, as sows in groups of four had more space to escape from a fight, their skin damage scores were significantly lower than sows in groups of eight, at all inspections (Table 1). Many sow houses with tether systems are significantly narrower than the 6.7m-wide house used here for the groups of eight, and have a floor area as low as 1.5m²/sow. Removal of the tethers, and leaving the same number of sows in the area, is likely to result in a high incidence of aggression and injuries which could lead to increased culling and reduced fertility.

Skin damage scores in both treatments did not decrease significantly until day 21, which indicates that aggression remained high in both treatments for at least the first two weeks.

Table 1. Skin damage-scores (mean \pm SEM) of sows in groups

	Group 4	Group 8	P
Day 1	8.7 \pm 1.7	15.7 \pm 1.9	*
Day 7	8.5 \pm 1.1	14.4 \pm 1.4	*
Day 14	6.7 \pm 1.0	10.9 \pm 0.8	**
Day 21	4.9 \pm 3.1	6.5 \pm 1.1	NS
Day 28	3.1 \pm 0.8	5.5 \pm 0.6	*
Total	6.4 \pm 0.6	10.6 \pm 0.9	***

Scores (1 to 5, depending on severity) were recorded on 12 body locations; the maximum score possible was 60.

3. Use of Loose Area and Feeding Stalls

Beattie and Walker (1999) found that sows housed in free-access stalls prefer to lie together in a communal lying area, especially when straw is provided. However, sows which have previously been kept in stalls in gestation, tend to spend more time in the feeding stalls than in the loose area when transferred to group-housing with free-access stalls (Walker and Kilpatrick, 1994). The sows in the current experiment had previously been housed in stalls, and familiarity with this system was expected to result in low usage of the loose area, initially, but to increase over time. Sows in fours

did show an increase in the proportion of time spent in the loose area, as the trial progressed, but this was not the case with the groups of eight. On each observation-day, sows in groups of four spent significantly more time in the loose area than sows in groups of eight (Table 2). This is likely to be a reaction to the lower floor space allowance in groups of eight.

Table 2. *Percentage (mean \pm SEM) of observations that sows spent in the loose-area*

	Group 4	Group 8	P
Day 1	41.2 \pm 11.0	11.1 \pm 4.0	*
Day 7	56.4 \pm 7.9	11.4 \pm 3.2	***
Day 14	71.8 \pm 10.3	9.1 \pm 2.8	***
Day 21	66.9 \pm 5.4	22.4 \pm 6.1	***
Day 28	70.4 \pm 5.4	20.1 \pm 6.7	***
Total	59.2 \pm 3.9	14.9 \pm 2.2	***

Percentage of observations over the six-hour period during which sows were observed (08:00-10:00; 11:00-13:00, and 15:00-17:00)

4. Feeding Behaviour

Observations at feeding showed no instances of sows swapping places or displacing others. This was probably due to the presence of full-length stalls, and the fact that the sows were wet-fed, both of which have been shown to reduce aggression (Bøe et al., 1999). However, after feeding had finished, swapping of stalls was common, but was not accompanied by aggression. While some sows seemed to spend almost all of their time in the same stall, the majority of sows showed no consistency in their use of particular stalls for feeding.

The trial reported here was too small to detect differences in sow performance or culling. In another study of sows housed individually on commercial farms, we have seen a significant number of broken or amputated claws which progress to severe lameness. Fighting amongst mixed sows on fully or partially-slatted floors, without bedding, is likely to lead to a high incidence of such problems. Sows in groups tend to move about more, and in a trial in the U.K., were found to have better muscle and bone development (Marchant and Broom, 1996) and improved cardiovascular fitness (Marchant and Rudd, 1993). Therefore, being more "physically fit", group-housed sows are likely to be more agile in the farrowing crate, with possible benefits to piglet

mortality, and feeding behaviour. They may also have a longer productive life, helping to offset the increased housing costs as a result of a higher space allowance.

Gilt Behaviour and Welfare in Groups

A 1996 survey on culling reasons in tethered and stall-housed sows, found that culling for reproductive disorders, lameness, and injury, was highest in the early parities (Boyle et al., 1998). This has important economic implications for the farmer, and welfare implications for the young sows. It was suggested that replacement gilts may have difficulty adapting to close confinement, having been housed in groups, often on bedding, during the rearing period, a system which is completely different to that in which they are destined to spend their productive lives.

An experiment was designed to compare gilt welfare in 2 loose-housing systems (with or without peat-moss bedding) in groups of four, with that of gilts housed in individual stalls. Gilts were introduced to treatment once confirmed pregnant, one month post-service, and remained in the housing treatments until day 110 of pregnancy. Gilts allocated to groups had previously been housed together in pens, eliminating the need to mix unfamiliar animals.

On first introduction to stalls, gilts made vigorous efforts to turn around and escape (Table 3). A similar reaction to being tied for the first time, has been described as a stress reaction (Baxter and Petherick, 1980). Frequent vocalisations and bar-biting are also considered to be indicators of stress, and were observed more often in stalled gilts. In contrast, loose gilts, especially those with bedding, were involved in exploring the pen or rooting at the floor and bedding.

Table 3. Behaviour of gilts (mean frequency/minute) during first hour in three housing systems

	<i>Stall</i>	<i>Loose bedded</i>	<i>Loose unbedded</i>
<i>Escape attempt</i>	0.12	0	0
<i>Turn attempt</i>	0.6 ^a	0 ^b	0 ^b
<i>Nose to floor</i>	0.7 ^a	2.9 ^b	1.6 ^b
<i>Bar-bite</i>	0.7 ^a	0.07 ^b	0.1 ^{ab}
<i>Grunt</i>	3.3 ^a	0.5 ^b	1.5 ^{ab}
<i>Smell fixtures and fittings</i>	2.1 ^a	0.3 ^b	0.1 ^b

^{a,b} Means with different superscripts are significantly different ($P < 0.05$)

Skin lesion scores of gilts in stalls increased throughout the trial period (Figure 2). Initially, this appeared to be due to their vigorous activity; later, towards the end of pregnancy, it may have been due to difficulties in manoeuvring, as body size increased. Loose-bedded gilts showed no increase in lesion score and unbedded gilts were intermediate. Overall, loose-bedded gilts had lowest lesion scores during pregnancy, and stalled gilts the highest. Had unfamiliar gilts been mixed, then it is possible that gilts in groups might have shown more lesions. These results suggest that housing pregnant gilts in the groups in which they were reared, especially if bedding is provided, poses fewer challenges to their welfare.

Figure 2. Mean skin lesion scores of gilts in stalls (ST), loose-bedded (LB), and loose-unbedded (LU) pens

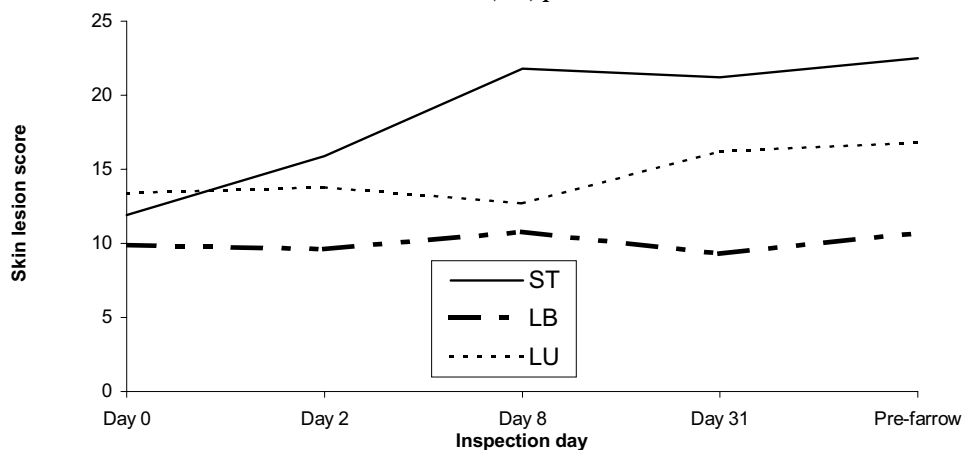

Behaviour in Farrowing Crates of Gilts Loose-housed in Pregnancy

Previous research at Moorepark has identified welfare problems (leg, foot, and skin lesions) in sows housed in farrowing crates pre- and post-parturition. These findings were based on sows which had been housed individually in stalls or tethers during pregnancy, however, there is some evidence that sows housed loose during pregnancy experience greater frustration when confined in farrowing crates (Marchant and Broom, 1993) which could result in worse skin damage.

The behaviour and skin lesion scores of gilts, from the three gestation housing systems mentioned above, was recorded in conventional farrowing crates.

Gilts housed loose on bedding during gestation were more distressed at first introduction to the farrowing crate. They made more turn attempts, and were more active during the first hour, which suggests that loose housing in pregnancy may merely postpone the stress reaction to close confinement. However, gilts from stalls, despite being familiar with close confinement, also showed evidence of distress, such as vocalisations and restlessness. Furthermore, skin lesions in all three treatments, increased during the first 24 hours in the farrowing crate. Thus, the farrowing environment may be distressful to gilts, irrespective of housing system, during gestation. However, at farrowing, gilts from stalls were calmer than those kept loose in pregnancy. Gilts from the bedded treatment entered the farrowing house with fewer skin lesions, and, despite a rise in skin lesions at farrowing, still had fewer skin lesions at weaning. Lesions incurred by these sows in the farrowing house appeared to heal faster.

Conclusions

- 1. Simple conversion of existing stall or tether housing, with minimal alterations and floor-area of c.2.2m² per sow, is likely to result in high levels of aggression and skin damage.*
- 2. A system based on groups of four sows, with c.3.0m² per head, with long divisions and free access to stalls, appears to work well, even with older sows accustomed to stalls.*
- 3. Improved physical fitness in group-housed animals may lead to improved sow longevity.*
- 4. Gilts kept loose in pregnancy experience distress when farrowing in crates.*
- 5. Gilts kept on bedding in pregnancy have healthier skin, and the effects persists to weaning.*

References

- Baxter, M.R. and Petherick, J.C. (1980). *The effect of restraint on parturition in the sow*. In: *Proceedings of the 6th International Congress of the Pig Veterinary Society*. N.C. Nielsen, P. Hogh and N. Bille (eds). p. 84.
- Beattie, V.E. and Walker, N. (1999). *Preference testing of resting areas by sows in group housed systems*. In: *Proceedings of the 33rd International Congress of the International Society for Applied Ethology*. 17th –21st August 1999, Lillehammer, Norway p. 140.
- Bøe, K. E., Anderson, I. L. and Kristiansen, A. L. (1999). *Feeding stall design and food type for group housed dry sows – effect on aggression and access to food*. In: *Proceedings of the 33rd International Congress of the International Society for Applied Ethology*. 17th –21st August 1999, Lillehammer, Norway p. 63.
- Boyle, L. A., Leonard, F. C., Lynch, P.B. and P. Brophy (1998). *Sow culling patterns and sow welfare*. *Irish Veterinary Journal* 51: 354 – 357.
- Edwards, S.A. (1992). *Scientific perspectives on loose housing systems for dry sows*. *Pig Veterinary Journal* 25: 40 – 47.
- Hartsock, T.G. and Curtis, S.E. (1983). *Some observations on the role of behaviour in swine production and future research needs*. *Applied Animal Behaviour Science* 11: 401 - 405.
- Jensen, P. (1984). *Effects of confinement on social interaction patterns in dry sows*. *Applied Animal Behaviour Science* 12: 93 – 101.
- Marchant, J.N. and Broom, D.M. (1993). *The effects of dry sow housing conditions on responses to farrowing*. *Animal Production* 56: 419 – 478.
- Marchant, J.N. and Broom, D.M. (1996). *Effects of dry sow housing conditions on muscle weight and bone strength*. *Animal Science* 62: 105 – 113.
- Marchant, J.N. and Rudd, A.R. (1993). *Differences in heart rate response at feeding between stall-housed and group-housed sows*. *Animal Production* 56: 423. (abstract).
- Walker, N. and Beattie, V.E. (1994). *Welfare of sows in loose housed systems*. In: *67th Annual Report, Agricultural Research Institute of Northern Ireland*. pp. 21 – 28.
- Walker, N. and Kilpatrick, D.J. (1994). *A study of spatial behaviour of pregnant sows housed in pens with various feeding and dung disposal systems*. *Animal Welfare* 3: 97 – 105.
- Weng, R.C., Edwards, S.A. and English, P.R. (1998). *Behaviour, social interactions and lesion scores of group-housed sows in relation to floor space allowance*. *Applied Animal Behaviour Science* 59: 307 – 316.

SOW CULLING AND PARITY PROFILES

***Ciarán Carroll,
Teagasc, Moorepark***

Introduction

Maximizing profitability is what pig production is all about. Good herd management will ensure maximum profitability. A sound culling policy is an integral part of herd management. It provides for the removal of less productive sows and the entry of replacement females on a regular basis, without disrupting the overall performance of the breeding herd. This will ensure that a stable parity profile can be maintained.

Culling Reasons

Sows are culled for a variety of reasons, e.g. old age, reproductive failure, poor performance, lameness, and disease, amongst others. All of these factors have to be looked at when determining the culling policy for a herd.

Another factor, which has arisen over the past year, is the cull sow price (Table 1). Income from cull sows should not be a major factor in determining culling policy. Cull sow income accounts for only 2% of total sales income (Table 2). Unfortunately, the cull sow price has become a significant factor in determining culling policy on a number of units. The knock-on effect of this is that a number of old sows have been retained in herds, and this, in turn, will result in decreased productivity. Now that pig prices have started to recover, it is time to start focussing on culling out these older sows in order to return to a more stable and productive parity profile.

Table 1. Cull sow price (p/kg, 1991 to 1998)

	<i>1991</i>	<i>1992</i>	<i>1993</i>	<i>1994</i>	<i>1995</i>	<i>1996</i>	<i>1997</i>	<i>1998</i>
<i>Price (p/kg)</i>	80	84	57	64	80	78	62	34

Source: Teagasc National Monitoring of Prices and Margins in Pig Production

Table 2. Cull sow sales as a percentage of total sales on a 100-sow integrated-unit

Pig Type	Number Sold	£	% of Total Sales
<i>Finisher Sales</i>	2,200	138,600	98
<i>Sow Sales</i>	45	3,150	2
Total	2,245	141,750	100

Assumptions: 45% replacement-rate
 22 pigs sold/sow/year
 70 kg finisher pig dead-weight
 90 p/kg nett price
 28p/kg cull sow price (£70 per sow)

Table 3. Reasons for cullings (Boyle et al., 1998)

Reason for Culling	% of Total Culls
<i>Old Age</i>	31
<i>Reproductive Failure</i>	30
<i>Locomotor Problems</i>	11
<i>Poor Performance</i>	11
<i>Death</i>	7
<i>Disease/Illness</i>	6
<i>Injury</i>	2
<i>Miscellaneous</i>	2
Total	100

Culling Rates

Irish farms had an average culling rate of 41% in 1998 (Teagasc PigSys Herd Recording Analysis). A number of studies have looked at culling rates and reasons. A survey of 25 pig units by Boyle et al. (1998) reported a culling rate of 43%. It varied considerably between herds, ranging from 26% to 70%. Culled females had produced an average of 4.6 litters. Old age and reproductive failure were the main reasons for culling, at 31% and 30% of all removals, respectively. Lameness and poor performance each accounted for 11% of culls. Thirty-two percent of animals culled for lameness had produced only one litter. Death accounted for 7% of removals and illness was responsible for 6% of culls.

Culling Age

Given that maximum productivity occurs at parities 3 to 5, the high culling rates in early parities is a worrying development. This high culling rate for young sows has been reported in a number of other studies. Dagorn and Aumaitre (1979) reported 21% of cullings after the first litter, and 50% of cullings before the fourth litter. In a U.S. study, D'Allaire et al. (1987) reported a culling rate of 50%, and these sows had produced an average of 3.8 litters. Table 4 shows that 42% of sows were culled before they reached their fourth litter (Boyle et al., 1998).

Table 4. Percentage of animals culled in each parity (Boyle et al., 1998)

Parity	% Culled	Cumulative %
0	3.6	3.6
1	14.6	18.2
2	14.0	32.2
3	9.8	42.0
4	5.1	47.1
5	5.8	52.9
6	8.0	60.9
7	11.0	71.9
8	11.8	83.7
9	6.7	90.4
10	2.2	92.6
11	0.2	92.8
Parity Unknown	7.2	100
Total	100	

These enforced cullings of young sows reduces the scope for objective culling, resulting in decreased herd output. To counter this, we need a better understanding of why sows are culled. This starts with good records - detailed reasons for all cullings must be recorded in every herd. There is not much factual information available on actual drop-out rates (and reasons) for young sows, i.e. between first and second litters, second and third litters, etc. However, with the use of on-farm computerized recording systems, it should be easy to identify when and why these sows drop out. This should result in greater attention to the sow as an individual, an increased awareness of its reproductive state at all times, and the ability to identify and dispose of less productive sows.

Target Culling Rates

The target culling rate is directly related to the average number of litters per sow (Table 5). A satisfactory target, based on producing 2.35 litters per sow per year, is 39 to 47%. This allows for an average production of 5 to 6 litters per sow before removal.

Table 5. Sow replacement-rate, related to the number of litters produced per sow

Average Number of Litters / Sow	2.1	2.35
3	70	78
4	52	59
5	42	47
6	35	39
7	30	34
8	26	29
9	24	27
10	21	24

Achieving this output per sow requires an integrated policy which spans from the number of replacement gilts being reared to the timing of removal of culled sows from the herd. This necessitates maintaining an adequate pool of gilts (about 12% to 15% of herd size) on the unit at all times. This should ensure that gilts are old enough (about 220 days) and heavy enough (about 140 kgs) at service. If the target number of gilts is not achieved and maintained regularly, problems can arise:-

- (1) Sows will not be culled when they should be, and herd performance will fall.
- (2) Culled sows will be replaced by gilts which are too young/small. These will produce small first litters, and tend to have a reduced potential breeding life.
- (3) Some culled sows will not be replaced and the herd size will fall, resulting in higher overhead costs per pig produced.
- (4) Sow feed usage will be excessive if too many maiden gilts are retained.

Culling Guidelines

Assuming an adequate number of maiden gilts of suitable weight, age, and size, are available, the following general guidelines should be used in deciding on culling a sow at weaning.

- (1) Two successive small litters - there may be some exceptions, e.g. gilts which were first served when they were too light, were overfed during pregnancy, lost excessive weight while suckling, and were weaned in poor condition.*
- (2) Failure to come on-heat despite hormone treatment. Allow a maximum of 18 days after weaning, including 7 days after hormone therapy.*
- (3) Second Repeat - the farrowing rate is less than 50% for sows which have repeated for a second time.*
- (4) Six or seven litters produced - sow and litter performance tends to deteriorate after 6 to 7 litters. Litter size falls, due mainly to an increase in stillbirths. Piglet size becomes uneven, with smaller piglets dying due to chilling or failure to suckle. Older sows have more udder problems and tend to be clumsy, both factors which lead to higher pre-weaning mortality.*
- (5) Locomotor Disorders - attention to legs at selection/purchase, along with good floors and slats, will reduce the need to cull for this reason. Also, preventing sows from becoming overweight will reduce culling for locomotor problems.*
- (5) Ill-health - e.g infectious vaginal discharges.*

Once the decision to cull has been made, the sow should be immediately removed from the herd, and replaced as soon as possible by a served-gilt. Holding on to a sow to try to restore condition prior to sale is not economically justifiable as sows have an FCE of about 7:1.

Following the above guidelines should ensure that a stable and productive parity profile is maintained on the unit, thus maximizing herd output, and therefore, profitability. As a guideline, this stable parity profile distribution should be similar to that in Table 6.

Table 6. Ideal parity distribution

Parity	%
1	17
2	16
3	15
4	14
5	13
6	11
7	10
8	<4

As mentioned previously, there is not much information available on why young sows drop out. Lameness and reproductive failure are likely to be the main reasons. Boyle et al. (1998) reported that 32% of sows culled for lameness, and 27% of sows culled for reproductive failure, had produced only one litter (Table 7).

Table 7. Distribution of sow cullings, by parity, within each of the five major categories (%) (Boyle et al., 1998)

Culling Reasons	Parity							
	0	1	2	3	4	5	6	7
Old Age	-	-	-	-	-	1	8	28
Reproductive Failure	10	27	22	13	7	7	6	4
Locomotor Problems	3	32	20	15	7	7	10	2
Poor Performance		2	28	23	6	14	14	9
Death	6	25	17	17	8	10	7	5

The breeding, selection, and rearing of replacement stock, needs to be focussed on to help reduce the high culling rates of young sows. Obviously, the selection of gilts with good legs is of critical importance. The housing and nutrition of gilts needs more attention. Adequate space (1.5m²) and good flooring are crucial for the development of stock with good legs. With regards to nutrition, feed gilts a sow diet from 90kg. This diet is higher in calcium and phosphorus (than a finisher diet), which is important for good bone formation. It also has a high energy:lysine ratio, which favours fat-deposition, essential for gilt replacements.

Serve gilts only when they are old enough (about 220 days), and heavy enough (about 140 kgs). This should help optimize ovulation rate, and thus litter size, and results in fewer young sows being culled for reproductive failure and poor performance.

Summary

A sound culling policy is an integral part of herd management, which helps to maximize unit-profitability. Sows are culled for a variety of reasons - old age, and reproductive failure, being the main reasons in Ireland. A factor which has become significant in the past year is the cull sow price, which has resulted in a number of old sows being retained in herds. This will lead to decreased productivity. Another development in recent years is the high culling-rates of young sows.

As pig prices recover, now is the time to focus on culling out the older sows, and replacing them with a steady in-flow of replacement females. Ensuring that the replacements are of a good age and weight should reduce the subsequent culling rate of young sows. The importance of keeping detailed records, of both the culling and the breeding programmes of the unit, cannot be over-emphasized. This will result in greater attention to the sow as an individual, an increased awareness of it's reproductive state at all times, and the ability to identify and dispose of less productive sows, thus ensuring that a stable and productive profile is maintained, and unit profitability is maximized.

References

- Boyle, L., Leonard, F.C., Lynch, B. and Brophy, P. (1998). Sow Culling Patterns and Sow Welfare. Irish Veterinary Journal incorporating Irish Veterinary Times 51(7): 354 - 357*
- Dagorn, J. and Aumaitre, A. (1979). Sow Culling: Reasons for and Effect on Productivity. Livestock Production Science 6 : 167 - 177*
- D'Allaire, S., Stein, T.E. and Leman, A.D. (1987). Culling Patterns in Selected Minnesota Swine Breeding Herds. Canadian Journal of Veterinary Research 51 : 506 - 512.*

INSURANCE REQUIREMENTS ON PIG UNITS

***Jim Finn,
Teagasc, Moorepark***

Introduction

The cost of establishing a new integrated pig unit today can be anything from £2,500-£3,000 per sow. The cost of replacing a pig unit as a result of an accident, may prove to be equally (or more) expensive. Because of the non-profit situation in production, for the last 12-15 months, very few, if any, pig producers would have funds to re-establish even part of a pig unit destroyed by fire, etc. Hence, there is a greater need than ever to have adequate insurance cover. The purpose of this paper is to make pig producers aware of what insurance cover is available, and what may be essential. Each individual unit will need to discuss its particular situation and needs with the insurance company.

1. Buildings, Permanents Fixtures and Fittings

(a) Replacement Value

The first priority in insuring any building is to establish the full replacement-cost, i.e. if the building was damaged today, what would it cost to put it back in-place. It is important not to under-estimate the cost. If the valuation of the building is too low, the amount paid, in the event of a claim, will be proportionate to what the building is insured-for, e.g. if insured for only 75% of the true-value, then only 75% of the amount of the claim will be paid. Permanent fixtures are generally covered with the buildings. Non-permanent fixtures can be covered under 'buildings' or under 'contents'.

(b) Perils Required

The next step is to establish for what perils the unit needs to be covered, e.g. fire, storm, lightning, explosion.

Fire, storm, and lightning cover should be standard for all units. Explosion may, or may not, be required.

(c) Premium-Rate

The premium-rate applied will vary from unit to unit and will be related to all of the following:

- *Structure of walls*
- *Structure of roofs*
- *Heating-system in operation*
- *Type of insulation*
- *Type of flooring, e.g. plastic, concrete*
- *General maintenance and state of repair of unit*

Guideline Rates / £1,000 Value

<i>Fire, lightning, and explosion</i>	<i>£1.30 - £1.80</i>
<i>Fire, lightning, explosion, and storm</i>	<i>£2.34-£2.80</i>

To insure a building for a further £10,000 in value will only add between £13 to £28 to the annual premium, depending on what cover is required. This could be a very small cost, in the event of a claim arising.

2. Contents of Houses

(i) General Equipment (mixing, feeding, augers, etc.).

Insure for replacement-value. Decide what perils need to be covered. The standard cover should be for fire, storm, lightning.

(ii) Inputs (feed, drugs, etc.)

Insure for replacement-value. Decide what perils need to be covered. The standard cover should be for fire, storm, lightning.

Guideline Rates / £1,000 Value

Contents £2.00-£2.20

3. Livestock (Pigs)

(a) Value

The first priority in this area is to establish the value of the stock by doing an inventory of the different categories, i.e. physically counting. Some units do this regularly, while others do not.

The value put on each can vary from time to time, depending on the sale price per kg, and the cost of inputs. Suggested values in the current situation are:

	Value/ Head (£)
Boars	60
Dry sows and served-gilts	150
Maiden gilts	80
Fatteners	50
Weaners.....	25
Suckling bonhams	15

It is important not to under-value the stock

(b) Perils Required

Having established the value of the stock, the next decision is what perils need to be covered. The following are available:

Fire

Smoke

Lightning

Explosion

Storm

Electrocution

Transit

(c) Premium-Rate

Guideline Rates / £1,000 Value	
Fire, lightning, and explosion	£1.80-£2.20
Fire, lightning, explosion, and transit	£2.00-£2.40

Where a haulier is engaged, it is important to check what his insurance covers.

4. Public Liability

Farmers may be legally liable for claims from the public due to injury, disease, or damage to property. This insurance indemnifies the insured up to £1 million, to cover claims plus legal costs and expenses. It is important, in the event of a claim, that pig producers are not proven negligent, i.e. has exercised "due care". The 'due care' clause comes into force in the event of a claim, and means that the onus is on the insured to take all reasonable precautions to prevent accidents, e.g. defective equipment should be repaired or replaced.

Approximate cost is £100/annum.

5. Employer's Liability

This insurance indemnifies the insured up to £10 million, in respect of his or her liability at law for damages, in the event of bodily injury or disease, to any person under a contract of service, or apprenticeship, with the insured, where the injury or disease arises out of, and in the course of, the business of farming. Where the employee also works on a farmer's other business, e.g. contracting, then an extension of cover may cost extra.

The insured is also indemnified against the claimant's costs and expenses in respect of such bodily injury or disease. Cover can be extended to include members of the producer's family.

N.B. The importance of having a Safety Statement cannot be over-emphasized in relation to employer and public liability claims.

Guideline Rate	
	£40 / £1,000 wages

6. Business Interruption (loss of income)

This insurance covers the loss of income incurred in the event of loss or damage to the out-buildings, stock, and contents, by the insured peril.

Not only is re-instatement or replacement of property and livestock necessary, but it is also vital to provide cover for associated costs, such as loss of income, and additional expenses necessary to maintain farming-activities, arising out of a fire or other peril. Good financial records can be very useful in determining what amount of cover is needed, and also in the event of a claim.

Guideline cost of premium would be approx. £200/annum for a 300-sow integrated-unit with a profit of £45,000 per annum.

7. Suffocation (FBD only)

In recent years, automation of ventilation systems on pig units has increased. Failure can often result in serious losses due to suffocation. It is possible to cover against loss of stock, in the event of such an occurrence. The insurance company will stipulate certain conditions to be adhered-to, e.g. alarms, back-up/fail-safe-systems, maintenance contract. The premium-rate will be related to value of stock, and the risk involved. Alarm and fail-safe systems are also a legal requirement in mechanically-ventilated houses.

8. All-Risks

This insurance is available for office equipment/computers. More and more records on pig units are being computerized. The loss of such records, due to damage to a computer, can be serious, and may take weeks or months to replace. This can incur a large cost in terms of professional time. Coverage of costs up to £25,000 is available.

Premium costs from £250/annum.

9. Agricultural Vehicles

Most pig farmers will have some farm vehicles and machinery, including tractors, and manure-spreaders. For mechanically-propelled vehicles, farmers can choose comprehensive, third-party, fire and theft; or third-party-only. Cover includes trailers/implements, whilst attached or detached, for third-party-risks only, without additional charge.

10. Personal Accident

Personal accident insurance covers the farmer for bodily injury caused solely and directly by violent, accidental, visible external means. Injury in sport may require an extension. Family members can also be covered. Cover includes death, capital-benefits, and weekly disability-benefits. It is important to ensure that value for money is given in any personal accident or illness-policy, and also that the cover is adequate to pay full cost of 'stand-in' staff for the period of illness or disability.

11. Home-Milling/Mixing Cover

Some pig units mill and mix their own feed. In most situations, the milling operation is a separate company. Insurance cover will also be necessary for this operation. It (the milling company) can be covered separately, or jointly, with the pig unit. Discuss with your insurer. Cover will be necessary for the following:

Buildings and fittings

Contents (including inputs and outputs)

Public liability

Employer's liability

Loss of income

The perils covered will be much the same as the pig unit, i.e. fire, storm, lightning. Explosion is a further risk in feed-mills.

Rate of premium will be related to the risk involved, as assessed by the insurance company.

12. Revenue Investigation ('Hibernian' only)

This insurance is available to cover farmers for costs involved in a 'tax-audit' or 'appeal'.

A typical cost of insurance cover for a 300-sow unit is as follows:

Summary of premium-cost of cover for a 300-sow unit	
Buildings and Fixed Equipment	1,395
Contents)	42
Inputs)	
Livestock	325
Public Liability	100
Employer's Liability	1,700
Loss of Income	200
Total	3,762

This comes to over £12/sow, or 57p per pig, @ 22 pigs/sow/year. There is no cover included, in this figure, for suffocation of pigs, personal accident, or sickness. If these are required, the cost may be higher.

The following may help to reduce the cost of the premium:

- Having buildings in good state of repair
- Having a Safety Statement in-place
- Having fire-prevention facilities, e.g. alarms, etc.

Claims Procedure

In the event of a claim arising, it is important to notify the insurance company as soon as possible after the incident. Usually, an assessor will visit the unit within 24-hours of the company being notified. If emergency repairs are necessary prior to his visit, only those which help to minimize the loss should be done. Having visited the farm, the assessor will ask the pig farmer to furnish a cost for the repair of the building to the insurance company - on the 'claim' form. The person(s) supplying this will have to be recognized within the trade. On receiving this, the insurance company will again

refer to their assessor, and he will decide whether the claim is realistic or not. Only on agreement by the assessor will the claim be paid.

Summary

Every pig unit needs insurance of some form. The type and level will vary from one unit to another. It is important for every pig producer to examine what their units are covered-for, at present, and then make whatever changes are necessary.

APPENDIX 1

EXAMPLE OF INSURANCE COST FOR A 300-SOW INTEGRATED-UNIT

1. Buildings and Permanent Fittings (Replacement Costs)

		£
Boars	8 places	9,000
Maiden Gilts	50 places	10,000
Dry-Sow Housing	250 places	94,000
Farrowing	70 places	105,000
Stage I Weaner	600 places	45,000
Stage II Weaner	600 places	45,000
Fattening	1,500 places	220,000
Offices }	1,000 sq. ft	30,000
Showers}		
Total (Buildings and Fittings)		£558,000

Assuming a cover-rate of £2.50/1,000 for fire, lightning, explosion, and storm, the premium for this cover will be:
 $£558 \times £2.50 = £1,395$

APPENDIX 1 continued /**EXAMPLE OF INSURANCE COST FOR A 300-SOW INTEGRATED-UNIT**

4. Livestock		£	£
5	Boars	@ £60/head	300
300	Sows and Served-Gilts	@ £150/head	45,000
13	Maiden Gilts	@ £80/head	1,040
1,280	Fatteners	@ £50/head	64,000
1,180	Weaners	@ £25/head	29,500
550	Suckling Bonhams	@ £15/head	8,250
3,328	Total		148,090

Assuming the pig stock will be covered for fire, lightning, explosion, and transit, the premium can be expected to be approx. £2.20/£1,000. The total cost of cover for the stock will, therefore, be:

$$148 \times £2.20 = £325$$

5. Public Liability

For a unit of 300-sows, the premium would be in the region of £100

6. Employer's Liability

At 125 sows per labour-unit, a 300-sow unit would require 2.4 labour-units. This could consist of 2 full-time persons, and 1 part-time/farm-relief person. The total wage-bill for these could be expected to be in the region of £40,000-£45,000. At a premium-rate of £40/£1,000 for Employer's Liability, this comes to between £1,600-£1,800/annum.

Acknowledgements

Bill Cahill, FBD, Fermoy; Co. Cork.

Robert Tyrell, Hibernian Insurance, Mallow, Co. Cork.

PHASE-FEEDING OF FINISHING PIGS

**Mike Tokach, Ph.D., Steve Dritz, D.V.M., Ph.D.,
Bob Goodband, Ph.D., and Jim Nelssen, Ph.D.,
Department of Animal Sciences and Industry, Kansas State University**

Introduction

Phase-feeding is the art of supplying the right diet at the right time. Nutritionists spend considerable time and effort estimating the nutrient requirements of pigs. We know that requirements for most nutrients decrease as pigs grow heavier. In this paper, we will discuss the importance of phase-feeding and provide illustrations on application of phase-feeding.

Why is Phase-feeding Important ?

If a single diet is used, pigs are either under- or over-supplied with nutrients for most of the growth-period (Figure 1). Even with multiple diets in a phase-feeding system, nutrients are over- or under-supplied much of the time (Figure 2). Use of phase-feeding simply decreases the amount of over- and under-feeding. The main reason why phase-feeding is important is to decrease the costs associated with under- or over-supplying nutrients in the diet.

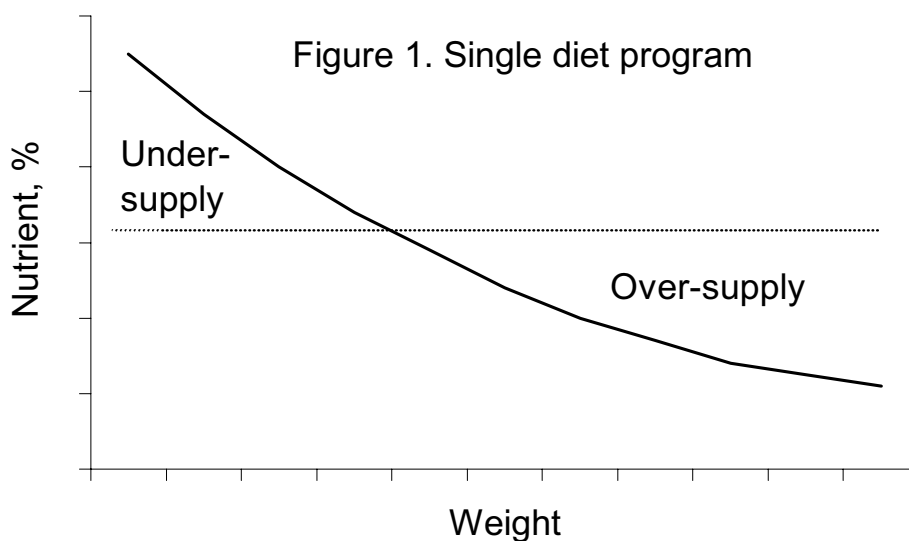

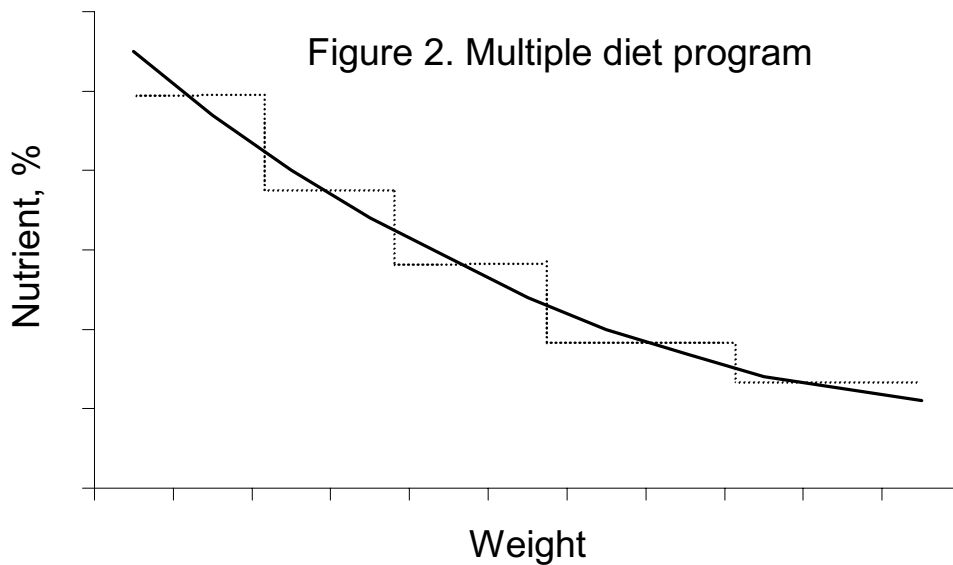

What are the Costs of Under- or Over-supplying Nutrients ?

The answer to this question depends on the nutrients which are over- or under-supplied. Amino acids (lysine) are usually the main target of a phase-feeding program. The costs of under-supplying lysine are accumulated in decreased growth-rate and increased feed/gain. The costs of over-supplying lysine include increased feed/gain, increased feed cost/kg gain, and increased nitrogen excretion.

The amount of calcium, phosphorus, trace minerals and vitamins being supplied in the diet also can be decreased in a phase-feeding manner. Minerals and vitamins are reduced in phase-feeding programs because of the decreased requirement as a percentage of the diet as pigs grow heavier. The advantage of reducing the level of vitamins and trace minerals is the cost-savings of using lower levels of pre-mix in the diets. The advantage to decreasing the level of phosphorus in a phase-feeding program includes a reduction in diet cost and decreased phosphorus excretion. The importance of reducing excretion of other minerals (zinc, copper) is already important in some part of the world and will increase in importance in the future.

Does Over-feeding Lysine Really Increase Feed/Gain ?

Recent results of the NPPC Lean Growth Evaluation Project demonstrate the negative impact of over-feeding lysine, especially in the late-finisher period. An

example is shown in Figure 3. Over-feeding lysine from 86 to 110 kg increased feed efficiency by 6 to 14%, depending on the degree of over-feeding. Feed efficiency is poor enough during the late-finisher period without exacerbating the problem with over-formulated diets.

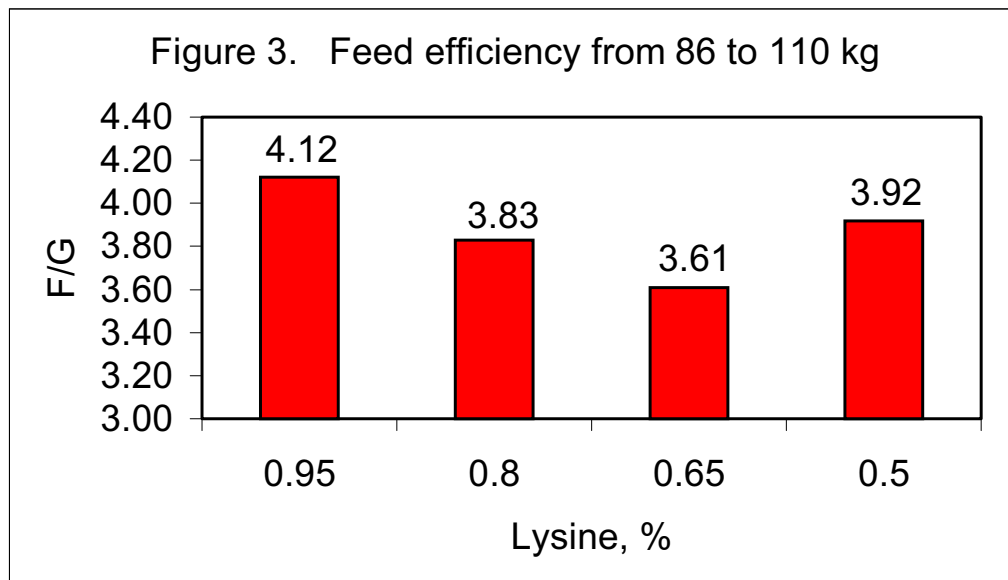

Over-feeding amino acids can decrease profits in three ways: Firstly, higher lysine diets are more expensive (an extra \$4 to 5.5/tonne (£3-£4) for every 0.1% lysine). Secondly, the poorer feed efficiency increases the cost further (another \$1 to 1.40/pig (£0.7 to £1.0) for every 0.1% lysine above the requirement, using results of the lean growth trial). Thirdly, nitrogen excretion is increased by over 10% for every 0.1% lysine over the requirement.

How Much Can Nitrogen and Phosphorus Excretion be Decreased with Phase-feeding ?

Many researchers have estimated the reduction in phosphorus and nitrogen excretion with phase-feeding, but relatively few experiments have actually measured the true response. Research published in recent years found multi-phase-feeding reduced ammonia emission by 3.6 to 18% compared to a two-phase diet system, depending on the type of production-facility (Van der Peet-Schwering et al.). The same researchers found that nitrogen excretion was reduced by 13 to 15% with multi-phase-feeding compared with two-phase-feeding. Verstegen (1995) estimated that phosphorus excretion could be reduced by 6% with phase-feeding.

How Many Diets are Practical ?

The answer to this question will depend on the production-system. Many factors need to be considered including: weight range of pigs being supplied by the feed-line, production capabilities of the feed-mill, group size, and change in nutrient-requirements as the pigs grow heavier.

The optimal number of diets to be fed in the finisher period (30 kg to market) will be fewer in Ireland than for most producers in the U.S. The two main reasons are: (1) pigs are fed to lighter final weights in Ireland (100 kg) than in the U.S. (110 to 130 kg), and (2) boars are fed in Ireland compared to castrates in the U.S. Many production systems in the U.S. feed 5 or 6-phase diet programs in the finisher period. To facilitate greater feed-mill efficiency, the same diets are usually fed to barrows and gilts, with different feed-budgets being used for each sex.

How are Phase-feeding Programs Implemented ?

Feed budgets are usually used to supply the correct amount of each diet to each group of pigs. An example feed-budget is listed in Table 1 for boars and gilts, with example F/G of 2.50 and 2.64, respectively, from 30 to 100 kg.

Table 1. Example of feed-budget for a phase-feeding system

<i>Diet Number</i>	<i>Boars</i>		<i>Gilts</i>	
	<i>Pig Wt. (kg)</i>	<i>Feed (kg/pig)</i>	<i>Pig Wt. (kg)</i>	<i>Feed (kg/pig)</i>
<i>Diet 1</i>	<i>30 to 53</i>	<i>50</i>	<i>30 to 50</i>	<i>45</i>
<i>Diet 2</i>	<i>53 to 73</i>	<i>50</i>	<i>50 to 75</i>	<i>50</i>
<i>Diet 3</i>	<i>73 to 90</i>	<i>50</i>	<i>75 to 85</i>	<i>45</i>
<i>Diet 4</i>	<i>90 to 100</i>	<i>25</i>	<i>85 to 100</i>	<i>45</i>
<i>Total</i>		<i>175</i>		<i>185</i>

Once the feed-budget is determined, the feed delivery is simplified. For example, a group of 200 boars will receive 10 tonnes (50 kg/pig x 200 pigs) of the first diet, before being switched to the next diet. The gilts would receive 9 tonnes before being switched to the second diet. Table 2 is provided to aid in determining an appropriate feed budget. For example, if F/G is 2.6, from 25 to 100 kg, and a diet was targeted

from 35 to 65 kg, approximately 82 kg/pig (10.3 + 10.8 + 11.2 + 11.7 + 12.1 + 12.6 + 13.0 = 81.7 kg) would be required for that diet.

Table 2. Quantity of feed (kg) needed for each 5-kg increment at various F/G values

Weight (kg)		Feed Efficiency from 25 to 100 kg					
Initial	Final	2.00	2.20	2.40	2.60	2.80	3.00
20	25	7.3	8.0	8.7	9.4	10.1	10.8
25	30	7.7	8.4	9.1	9.9	10.6	11.3
30	35	8.0	8.8	9.6	10.3	11.1	11.8
35	40	8.4	9.2	10.0	10.8	11.6	12.4
40	45	8.7	9.6	10.4	11.2	12.0	12.9
45	50	9.1	9.9	10.8	11.7	12.5	13.4
50	55	9.4	10.3	11.2	12.1	13.0	13.9
55	60	9.8	10.7	11.6	12.6	13.5	14.4
60	65	10.1	11.1	12.1	13.0	14.0	14.9
65	70	10.5	11.5	12.5	13.5	14.5	15.5
70	75	10.8	11.9	12.9	13.9	14.9	16.0
75	80	11.2	12.2	13.3	14.4	15.4	16.5
80	85	11.5	12.6	13.7	14.8	15.9	17.0
85	90	11.9	13.0	14.1	15.3	16.4	17.5
90	95	12.2	13.4	14.6	15.7	16.9	18.0
95	100	12.6	13.8	15.0	16.2	17.4	18.6

How Many Diets do Producers in the U.S. Use ?

A survey by the U.S. Department of Agriculture found that the number of diets used was dependent on size of the producer. For producers marketing more than 10,000 pigs per year, 74% used four or more diets in their phase-feeding program. Only 28% of the producers marketing less than 2,000 pigs per year used four or more diets. For producers marketing 2,000 to 10,000 pigs per year, 57% used four or more diets. Very few producers used only one diet for the grow-finish period (<5% of the smallest producers and <1% for larger producers).

SUMMARY

Economic returns to pork production have been at historically low levels during the last two years. Uses of technology, like phase-feeding, will not provide a guarantee for profitability; however, phase-feeding has become more and more essential to reduce cost.

Phase-feeding reduces feed-cost by decreasing the quantity of protein and phosphorus supplied in the late-finisher diets. Because of the reduction in protein and phosphorus excretion, phase-feeding also may reduce waste-management costs. Application of phase-feeding has been made easier with the use of feed-budgets and all-in, all-out technology.

OUTLOOK FOR IRISH PIG INDUSTRY

**Pat Tuite,
Teagasc, Drogheda.**

Introduction

This paper examines the factors which will affect both the producer price of pigmeat and the costs of producing it in the medium-term. Some factors will adversely affect profitability, while others will contribute to much-improved returns in 2000 and 2001. Because of the fudging of the traditional European pig cycle, and the aggressive expansion of U.S. exports, it has become more difficult to predict E.U. pigmeat prices with accuracy. High prices similar to 1996 are most unlikely in future, unless a major supply-crisis is created.

E.U. Pigmeat Prices

Pigmeat Supplies

EU production is declining more slowly than earlier forecasts had predicted. Despite the record-breaking losses incurred across Europe and the U.S. during the last 14 months, the scale of cut-backs in the various breeding herds has been largely modest (Table 1).

Table 1. % changes in sow breeding herds (April-June Census '99/'98)

United Kingdom	-15.5%
Netherlands	-12.7%
Austria	-7.9%
U.S.A.....	-6.0%
France	-3.5%
Ireland.....	-2.4%
Belgium.....	-1.7%
Germany.....	+0.7%
Italy.....	+0.8%
Denmark.....	+ 1.7%
Spain.....	+ 7.9%

With the exception of Italy, Denmark, and Spain, the reduction in gilts mated is much greater than the reduction in the total breeding herds. This would indicate that herd contraction is continuing in the majority of E.U. countries.

In terms of pig numbers, the 4 countries showing the greatest reduction in supplies are: U.S., The Netherlands, U.K., and France.

When these and previous changes in the breeding herds are used to forecast pig supplies, the following picture emerges (Table 2).

Table 2. E.U. and U.S. pig supplies (million head)

<i>E.U. - 15</i>	<i>1998/1999</i>	<i>1999'2000</i>	<i>±%</i>
<i>July - September</i>	50.6	50.9	+0.6
<i>October - December</i>	56.7*	55.1	-2.8
<i>January - March</i>	53.8	51.4	-4.5
<i>April - June</i>	50.7	48.8	-3.7
.....			
<i>U.S.A.</i>	<i>1998/1999</i>	<i>1999'2000</i>	<i>±%</i>
<i>July - September</i>	25.0	24.9	-0.5
<i>October - December</i>	27.5*	26.3	-4.4
<i>January - March</i>	25.5	24.8	-2.9
<i>April - June</i>	24.3	23.6	-3.0

Source: ZMP & Eurostat

While both the E.U. and U.S. are predicting a drop in supplies in the final quarter of 1999, these data are being compared with record-output-levels in the final quarter of 1998.

It will not be until the 2nd quarter of 2000 before forecasted supplies will be similar to Q2 of 1998. There are no apparent reasons why E.U. and U.S. supplies will not continue to decline slowly during the second-half of 2000.

The U.S. have an estimated 450,000t pigmeat in storage.

E.U. Market Management

Approx. 418,000t of pigmeat was accepted into APS between 28/09/'98 and 14/09/'99, when the scheme closed. This scheme was introduced to relieve some of the pressure on the E.U. pigmeat market, caused by increased supply-levels within the E.U. and reduced exports to non-E.U. markets, especially Japan and Russia.

This volume represents approx. 7 million pigs or 12 days' production.

So far, over 155,000 tonnes has been removed and sold, mainly to Japan and Russia. A further 250,000 tonnes will be released from APS by May 2000.

Pigmeat export-refunds were reduced by 25% from July 14th, '99, to 11.8p/kg to Eastern Europe, and 31.5p/kg to other destinations. Exports to Russia had a special refund of 41.7p/kg up to September 8th, '99.

Pigmeat Consumption

In response to lower prices, pigmeat consumption has increased in most E.U. countries, with the exception of the U.K. and Belgium.

Reports of dioxin contamination of pork in Belgium, The Netherlands, and Denmark, have damaged the image of pigmeat (as well as poultry and beef). This has been compounded by recent reports from France, where sewage-treated meat-and-bone-meal was fed to meat animals.

There is an increased need for quality assurance and traceability, to give the consumer full confidence in Irish pigmeat. Any 'cowboy activities' which compromise meat safety will damage the industry for every producer.

In the U.S., pigmeat consumption rose by 8% in the first six months of 1999.

Agenda 2000 and World Trade Agreement

The Agenda 2000 reforms do not affect the pig sector directly. The impact of the Berlin Agreement will be felt indirectly through changes in support for beef and cereals. The reduction in support for beef has 'cross-commodity' consequences for the demand for beef-substitutes including pigmeat. A fall in beef prices might result in an associated fall in the price of pigmeat. The reduction in cereal support-prices will lead to a fall in compound feed prices. The effects of these changes tend to offset each other.

Pigmeat imports into the E.U. have risen from 28,000t in 1994 to 60,000t in 1998. This level is unlikely to increase during the next few years. But when the next World Trade Agreement is signed in 2002 (at the earliest), the U.S. could have increased E.U. access for their pigmeat. In the meantime, a major battle will be fought to protect the European pig industry from cheap imports with unequal production advantages.

On the global front, it will be difficult to compete on price with U.S. pigmeat on third-country markets. These markets have acted as a safety-net for surplus E.U. production in the past. It may be necessary to wind-down E.U. output towards 102-103% self-sufficiency from the 107% level of 1998.

Irish Pigmeat Prices

In the first 9 months of 1999, the Irish pigmeat price varied from 82% to 101% of the E.U. average reference price. It averaged 91.4% of the E.U. price for this period. Traditionally, the difference is approx. 6%.

The Irish pigmeat price is normally similar to the Danish and Dutch reference prices - the two principal pigmeat exporters in the E.U. Whereas the Irish prices now attract

a VAT refund of 4%, the Dutch have a VAT refund of 5.6%, and the Danes get an end-of-year-bonus of 7p/kg (average for past 10 years).

Irish pigmeat prices will continue to remain at the bottom of the E.U. table unless there is more competition for pigs within the island. Slaughtering capacity needs to be constantly monitored, to avoid a shortage, and a repeat of the experience of the first quarter of 1999.

Production Cost Trends

Feed Costs

Feed costs represent about 65% of the total cost of pig production. The trend is for feed costs to fall and non-feed costs to rise.

As part of the Berlin Agreement, the intervention price for cereals will be cut by 15% in two equal steps, starting in the 2000/1001 campaign (i.e. by £14 per tonne to £79.79 per tonne). Further reductions from 2002/2003 onwards will be made in light of market developments. Because of the high inclusion of cereals in Irish pig diets, these adjustments will continue the downward trend in pig feed prices. The price of cereal substitutes tends to track cereal prices.

With meat-and-bone meal excluded from Irish pig diets, protein sources are confined to a few vegetable proteins (S.B.M., rapeseed and sunflower meal). No supply problems are forecasted, although the price of soyabean-meal can be erratic.

While the cost of feed manufacture in Ireland can be argued to be excessive, it is unlikely to be addressed, or corrected, while compounder credit runs at 5 to 6 months, rather than the normal 2 to 3 months.

Labour Costs

The pig industry is facing a two-pronged problem with labour, viz. supply and cost.

Because of more attractive alternatives, fewer young people are entering the industry, and more and more well-trained, experienced-people are leaving. Against this background, labour-costs must rise above the current level of £6.50 to £7 per pig.

To attract and retain staff, good working-conditions must be provided. Feeding and ventilation must be automated, while all pig movements must be streamlined. Costs can be reduced by using skilled labour effectively, and employing part-time semi-skilled staff.

Financial Costs

The accumulated losses of 1998/1999 have now to be financed on top of normal loan repayments. In any event, the maximum repayment capacity is 10p/kg dwt.

Because of reduced interest-rates, and longer-terms, it is possible to borrow over £1,200 per sow and remain within the maximum repayment guideline (Table 3).

It is important for producers to take full advantage of the lower interest-rate environment which is forecast to remain relatively low for several years.

Table 3. Borrowing capacity / Integrated sow*

Term	Interest-Rate (£)		
	5%	7.5%	10%
<i>5 years</i>	<i>680</i>	<i>641</i>	<i>605</i>
<i>7 years</i>	<i>909</i>	<i>838</i>	<i>775</i>
<i>10 years</i>	<i>1,210</i>	<i>1,083</i>	<i>974</i>
<i>12 years</i>	<i>1,389</i>	<i>1,218</i>	<i>1,078</i>
15 years	1,624	1,389	1,199

* Assumes £154/sow repayment capacity (i.e. 10p/kg dwt.).

Environmental Protection Costs (IPC Licence)

By September 1st, 1999, 63 large pig units had applied for an IPC Licence, and 17 licences had been granted. By March 2000, 110 pig units are due to apply for an IPC licence, which represents 54% of all sows. When the threshold falls to 400 sows in September 2000, it will suck in another estimated 33 units, giving a total of over 60% of sows liable.

IPC licensing is expensive.

There is a major cost involved in applying for a licence. This is followed by the varying costs of compliance, and then the on-going operating costs.

When manure-disposal is included, the cost of environmental protection could be 3-4p/kg dwt. on some units. This is an issue which must be addressed, but the costs involved are unlikely to fall.

Welfare Costs

Apart from stocking-rate requirements, and the non-tethering of pregnant sows after January 2006, other welfare costs are not clearly defined. The requirement for progeny from loose-housed sows for the U.K. market has almost evaporated, and there is no clear statement of the likely extent of this market next year. Against this background, no costly modification should be made to existing houses.

Summary

Margins in pig production will be greatly improved in 2000 / 2001 against a background of reduced pig supplies. While feed and financial trends are downward, other production costs are likely to increase. Labour and environmental-protection costs will be more significant in future.

WET-FEEDING FIRST-STAGE WEANERS

***Peadar Lawlor,
Teagasc, Moorepark.***

Introduction

Liquid Feeding has been reported to stimulate increased intake post-weaning, and thus increase post-weaning growth-rates (Brooks et al., 1996; Jensen and Mikkelsen, 1998). For this reason, and to reduce labour input, automated wet-feed systems for first-stage pigs have been installed on several pig farms in Ireland. Since their installation, few of these systems have operated without problems, and on some units, pig growth-rates have decreased, and FCE has disimproved dramatically, in comparison to dry-feeding.

Jensen and Mikkelsen (1998) summarized the results of ten studies on wet-feeding of first-stage pigs, and found that ADG was increased by 12% when compared with dry-feeding. They also reported that ADG of fermented wet-fed pigs was 13% higher than that found with fresh wet-feeding. Regardless of the type of wet-feed provided to weaned pigs, a deterioration in FCE is normally found, relative to dry-fed pigs.

*Any benefit from wet-feeding newly-weaned pigs is likely to arise from an increase in feed intake. Increased intake post-weaning, as achieved by liquid feeding, has been found to help maintain gut integrity (which normally deteriorates with weaning), and, in particular, villous height (Deprez et al., 1987; Pluske et al., 1996). Maintenance of gut-integrity would serve to maintain the digestive capacity of the pig, and thus prevent the post-weaning "growth lag" often experienced at this time. Fermented liquid feed may offer further advantages to pig performance, because the pH of this material is normally about 4, which will help to eliminate deleterious microbes, such as *E. coli* and salmonella, from the digestive tract. Mikkelsen and Jensen (1998) found that fermented liquid feed reduced stomach pH, and lowered the number of enterobacteria (including *E. coli*) throughout the digestive tract. A low pH in the feed will also help to promote protein digestion in the stomach (Longland, 1991). Both factors can help prevent diarrhoea in the early post-weaning period.*

The objective of this series of experiments was to examine the effect of liquid feeding on post-weaning performance, and examine any residual effects on pig performance up to slaughter.

Materials and Methods

Four experiments were undertaken. Pigs were weaned at c.26 days of age, and formed into single-sex groups, of even-weight. Commercially-available starter and link diets were purchased, while weaner and finisher diets were manufactured at the Moorepark feed-mill.

Experiment 1

The objective was to examine the effect of feeding a fresh wet-feed for 27 days after weaning. The treatments used were: (1) dry-pelleted feed, and (2) fresh wet-feed. In both cases, 2 kg starter diet per pig, 5 kg link diet per pig, and weaner diet, were fed to 27 days post-weaning. Diets are described in Table 1.

Experiment 2

The objective here, as in Experiment 1, was to examine the effect of feeding a fresh wet-feed for 27 days after weaning. The treatments used were: (1) dry-pelleted feed, and (2) fresh wet-feed. In both cases, 3 kg starter diet per pig, 6 kg link diet per pig, and weaner diet, were fed to 27 days post-weaning. Diets are described in Table 1.

Experiment 3

The objective in Experiment 3 was to assess the response to fresh wet-feed, or an acidified wet-feed, for 27 days after weaning. The treatments were: (1) dry-pelleted feed, (2) fresh wet-feed, and (3) acidified wet-feed. In all cases, 3 kg starter diet per pig, 6 kg link diet per pig, and weaner diet, were fed to 27 days post-weaning. Diets are described in Table 1.

Experiment 4

The objective in Experiment 4 was to assess the response to acidified wet-feed, or fermented wet-feed for 27 days after weaning. The treatments were: (1) dry-pelleted

feed, (2) acidified wet-feed, and (3) fermented wet-feed. In all cases, 3 kg starter diet per pig, 6 kg link diet per pig, and weaner diet, were fed to 27 days post-weaning. Diets are described in Table 1.

Table 1. Declared nutrient content of experimental diets

Diet	Experiment 1		Experiments 2, 3, and 4		Experiments 1, 2, 3, and 4	
	Starter	Link	Starter	Link	Weaner	Finisher
Specification						
Crude oil % (min)	8.5	6	10	8	3.5	2.8
Crude protein % (min)	21	21	24	22.5	21	18.7
Crude fibre % (max)	2	3	2	3	2.9	3.7
Crude ash % (max)	6.5	6	6	6.2	4.5	4.3
Lysine	1.6	1.5	1.7	1.5	1.36	1.12
Vitamins						
A (iu/kg)	20,000	10,000	13,000	13,000	6,000	2,000
D ₃ (iu/kg)	2,500	2,000	2,000	2,000	1,000	500
Alpha tocopherol (iu/kg)	200	125	250	200	100	40
Additives						
Copper (mg/kg)	175	155	165	165	175	100
Olaquinox ¹ (mg/kg)			100	50		
Salacin (mg/kg)	50	50				
Tylosin (mg/kg)					40	

¹ Not included in Experiment 4

The duration of each experiment was 27 days, after which pigs were fed a common weaner diet in pelleted form, and a common finisher diet as a 3:1 water to meal wet-mix. Intakes, growth-rates, and carcass-characteristics, were recorded to slaughter. Pigs were fed as follows:

Dry Feeding

Pigs were fed 3 times daily in the first week, and ad-libitum thereafter, with care being taken to avoid wastage. Feeders were allowed to empty at least twice-weekly, to avoid a build-up of stale feed. Intakes were recorded weekly. Water was available from BALP bowls.

Wet Feeding

Pigs were fed a 2:1 water to meal ratio-diet 3-times daily in the first week, and ad-libitum thereafter, with care being taken to avoid wastage. In the case of fresh wet-feed, feed was mixed each day. The acidified wet-feed diet was prepared daily, with lactic acid added to the feed to reduce feed pH to 4.0. The fermented diets were

prepared by mixing feed in a container so that the container always contained a reserve at least equal-to the quantity of feed required for the next day's feed. This reserve acted as the inoculant when fresh feed and water were added. Feeders were washed twice-weekly, and fresh water was also available from BALP bowls.

Results and Discussion

Fresh Wet-Feed

Intake

Experiments 1 and 2 compared the feeding of fresh wet-feed with conventional dry-feeding. In both experiments, intake was increased as a result of wet-feeding in all periods up to day-27. Increased intake has previously been found with fresh wet-feeding of newly-weaned pigs (Partridge et al., 1992; Kornegay and Thomas, 1981). Intake from day-27 to transfer at 55 days, was similar for both wet-fed and dry-fed pigs in both experiments, but intake was still higher for wet-fed pigs in the period day-0 to day-55 in Experiment 1, and Experiment 2, respectively. In Experiment 2, dry-fed pigs were found to have increased intake in the finisher stage (day-55 to day-135). This effect is difficult to explain.

ADG

ADG was decreased as a result of wet-feeding in the period day-0 to day-27 in Experiment 1, and Experiment 2, respectively. This was contrary to the findings of Partridge et al. (1992), where wet-feeding was found to increase ADG in a three-week trial. Dry-feeding was also found to support greater ADG than wet-feeding in one experiment, reported by Kornegay and Thomas (1981), but when the results of the three reported-experiments were compiled, ADG of both wet- and dry-fed pigs were similar. In Experiment 1, there was a tendency for ADG of wet-fed pigs to increase in the second-stage weaner-period (day-27 to day-54) ($P=0.15$), and, in both experiments, ADG was similar in the period day-0 to day-55, indicating the occurrence of compensatory growth. In Experiment 1, pigs from both treatments reached similar slaughter-weights at c.132 days. However, in Experiment 2, dry-fed pigs had increased ADG in the period day-55 to day-135, which gave the dry-fed pigs a 2 kg weight advantage at slaughter.

FCE

FCE was dis-improved by wet-feeding in both Experiments 1 and 2, in periods day-0 to day-27, and day-0 to day-55. Brooks et al. (1996) also reported that FCE was dis-improved in their experiments, and when reporting their results, they cautioned that the term 'feed-usage' be used rather than 'feed intake', since high levels of feed can be wasted when wet-feeding first-stage weaners. Better feeder-design may help reduce this wastage, and Partridge et al. (1992) found that FCE was unaffected by wet-feeding when an experimental-automated wet-feeder, which dispensed feed and water at a ratio of 1:1, was used. Brooks et al. (1996) also found that FCE of wet-fed pigs was similar to that found for dry-fed pigs, when their feeder-design was improved. In Experiments 1 and 2 of the present study, feeder-design was very wasteful, and better-designed feeders were used in Experiments 3 and 4.

Table 2. Effect of wet-feeding, in first-stage, on pig performance (Experiment 1)

	Treatment		F-test ¹
	Dry	Wet	
Number of pens/treatment	12	12	
Number of pigs/pen	16	16	
Weights (kg)			
Initial	8.4	8.4	
Day 27	17.5	16.2	***
Day 54	36.3	35.6	NS
Day 132	95.3	95.7	NS
Carcass	71.8	71.9	NS
ADFI (g/day)			
Day 0-27	431	542	***
Day 27-54	1,112	1,129	NS
Day 0-54	773	837	**
Day 54-132	1,997	2,001	NS
ADG (g/day)			
Day 0-28	338	286	**
Day 27-54	684	707	NS
Day 0-54	512	498	NS
Day 54-132	758	765	NS
FCE			
Day 0-28	1.28	1.9	***
Day 27-54	1.63	1.6	NS
Day 0-54	1.51	1.68	***
Day 54-132	2.63	2.62	NS

¹ * = P<0.05, ** = P<0.01, *** = P<0.001

Table 3. Effect of wet-feeding, in first-stage, on pig performance (Experiment 2)

	Treatment		F-test
	Dry	Wet	
Number of pens/treatment	10	10	
Number of pigs/pen	15	15	
Weights (kg)			
Initial	7.8	7.8	
Day 27	18.3	17.3	**
Day 55	35.4	35.3	NS
Day 135	96.4	94.5	*
Carcass	73.4	72	+
ADFI (g/day)			
Day 0-27	517	617	***
Day 0-55	828	875	***
Day 0-135	1,517	1,501	NS
ADG (g/day)			
Day 0-27	391	352	**
Day 0-55	504	493	NS
Day 0-135	656	640	+
Carcass	622	605	+
FCE			
Day 0-27	1.32	1.76	**
Day 0-55	1.64	1.78	**
Day 0-135	2.31	2.35	NS
Carcass	3.20	3.18	NS

Acidified Wet-Feed

Benefits reported, from experiments with fermented liquid feed, are thought to arise from microbial production of lactic-acid, and a reduction in diet pH, which ultimately causes a lowering of gastric pH (Geary et al., 1999; Mikkelsen and Jensen, 1998). This reduction in gastric pH has 2 main benefits: it reduces the population of deleterious micro-organisms, such as coliforms, in the digestive tract (Mikkelsen and Jensen, 1998), and it helps to provide suitable conditions for pepsin activity (Longland, 1991). Pepsin is a protein-degrading enzyme in the stomach. To overcome the difficulties in controlling fermentation of liquid feed (Brooks et al., 1999), and yet to simulate its effect, Experiment 3 had a wet-feed treatment which was supplemented with lactic acid, so that diet pH was c. 4.0. Geary et al. (1999) had shown that a wet-

feed supplemented with lactic acid gave similar growth performance to that found with a fermented wet-feed.

Intake

In Experiment 3, intake was unaffected in the period day-0 to day-13. Intakes were increased with both wet-feeds, fresh and acidified, in the period day-13 to day-27, and day-0 to day-27, respectively. This increase in 'feed usage' is consistent with previous findings with fermented liquid feed (Russell et al., 1996). Intake in the period, day-27 to day-62, was unaffected by previous post-weaning treatment, but intake from day-0 to day-62 was higher for fresh wet-feed than that found with either dry-feed, or acidified wet-feed, which had similar intakes.

ADG

ADG of both dry-fed and fresh wet-fed pigs were similar, but lower, than that found for acidified wet-fed pigs in the period, day-13 to day-27. This was the only period when a significant treatment-effect for ADG was found. Other studies have consistently found increases in ADG when fermented feed was fed (Partridge et al., 1992; Russell et al., 1996).

Table 4. Effect of feeding fresh wet-feed, and acidified wet-feed, in first-stage, on pig performance (Experiment 3)

	Treatment			F-test
	Dry	Wet-Fresh	Wet-acid	
Number of pens/treatment	8	8	8	
Number of pigs/pen	14	14	14	
Weights (kg)				
Initial	7.7	7.7	7.7	
Day 27	18.6	18.8	19.5	NS
Day 62	43.8	43.7	43.9	NS
ADFI (g/day)				
Day 0-27	531 ^b	622 ^a	616 ^a	**
Day 0-62	983 ^b	1,030 ^a	1,005 ^{ab}	*
ADG (g/day)				
Day 0-27	408	416	433	NS
Day 0-62	579	577	585	NS
FCE				
Day 0-27	1.30 ^b	1.50 ^a	1.43 ^a	***
Day 0-62	1.70 ^b	1.79 ^a	1.72 ^b	***

^{a,b} Means in a row not sharing a common superscript differ significantly ($P < 0.05$)

FCE

FCE was unaffected by treatment in the period, day-0 to day-13, which may have been as a result of reduced feed-wastage, due to the improved feeder-design used in the present experiment. In the period day-0 to day-62, acidified wet-fed pigs had similar FCE to dry-fed pigs, with the FCE of fresh wet-fed pigs being significantly poorer. Russell et al. (1996) found that FCE was consistently dis-improved by wet-feeding.

Fermented Wet-Feed**Intake**

Fermented wet-fed pigs had similar intakes to dry-fed pigs in the period day-0 to day-13, though lactic acid supplementation of wet-feed increased intake at this time. At all other periods, day-13 to day-27, and day-0 to day-27, intake was lower for dry-fed pigs than for either of the two wet-feed treatments. This is consistent with the findings in Experiments 1, 2 and 3.

ADG

As with Experiment 3, the acidified wet-feed increased ADG, when compared with dry-feed, in the period day-13 to day-27. This type of response has previously been found in experiments comparing fermented liquid-feed with dry-feed (Russell et al., 1996). However, in the same period, the ADG of acidified wet-fed pigs was also significantly higher than that found for the fermented wet-feed. In the period, day-0 to day-27, ADG also tended to be higher for acidified wet-feed than for either of the other two treatments ($P=0.11$). These results are in contrast with that found by Geary et al. (1999), where wet-feed, supplemented with lactic acid, gave similar ADG to that found with fermented wet-feed.

FCE

As with previous experiments, FCE, with both wet-feed treatments, was less efficient than dry-feeding. This was the case in periods day-0 to day-13, day-13 to day-27, and day-0 to day-27. Even though trough design in this experiment was good, it is evident that wet-feeding newly-weaned pigs leads to considerable wastage of expensive diets.

Table 5. Effect of feeding fresh wet-feed, and acidified wet-feed, in first-stage, on pig performance (Experiment 4)

	Treatment			F-test
	Dry	Wet-acid	Wet-fermented	
Number of pens/treatment	8	8	8	
Number of pigs/pen	14	14	14	
Weights (kg)				
Initial	8.0	8.0	8.0	
Day 27	17.7	18.5	17.3	+
ADFI (g/day)				
Day 0-27	457 ^b	582 ^a	531 ^a	***
ADG (g/day)				
Day 0-27	361	389	347	NS
FCE				
Day 0-27	1.27 ^b	1.50 ^a	1.53 ^a	***

Conclusions

Feeding fresh wet-feed to weaned pigs does not increase pig growth-rate, and, in fact, can reduce it. It has also been found to be wasteful of feed, leading to unacceptable FCE in the first-stage. There are, perhaps, some merits to feeding lactic acid-supplemented wet-feed, as feed-wastage was reduced, and ADG increases were seen at day-13 to day-27 post-weaning. However, lactic acid is expensive (up to £2,200 per tonne), and supplementation-levels need to be high to achieve a diet pH of 4.0 (50, 45, and 30 kg/tonne, for starter, link, and weaner diets, respectively). In theory, fermented wet-feed should give similar performance to that found with acidified liquid-feed. However, the fermentation of wet-feed is highly unpredictable, and growth of undesirable bacteria and yeasts can cause problems. Even though an inoculant was used in the fermented wet-feed, growth-rate was reduced, and FCE dis-improved. It is

concluded that there is no benefit from wet-feeding weaned-pigs, whether fed fresh, acidified, or fermented.

References

- Brooks, P.H., Moran, C. and Beal, J.D. (1999) Liquid feeding of pigs: potential for reducing environmental impact and for improving productivity and food safety. *Biotechnology in the Feed Industry. Proceedings of Alltech's 15th Annual Symposium*. Eds: T.P. Lyons and K.A. Jacques. pp.111-129.
- Brooks, P.H., Geary, T.M., Morgan, D.T. and Campbell, A. (1996). *New developments in liquid feeding. The Pig Journal*. 36: 43-64
- Deprez, P., Deroose, P., van den Hende, C., Muylle, E. and Oyaert, W. (1987). *Liquid versus dry feeding in weaned piglets: the influence on small intestine morphology. Journal of Veterinary Medicine*. 34: 254-259
- Geary, T.M., Brooks, P.H., Beal, J.D. and Campbell, A. (1999) Effect on weaner pig performance and diet microbiology of feeding a liquid diet acidified to pH 4 with either lactic acid or through fermentation with *Pediococcus acidilacti*. *Journal of the Science of Food and Agriculture*. 79:633-640.
- Jensen, B.B and Mikkelsen L.L. (1998) *Feeding liquid diets to pigs. Recent advances in animal nutrition*. Ed: P.C. Garnsworthy and J. Wiseman. Nottingham University Press, Thrumpton, Nottingham. 107-126.
- Kornegay, E.T. and Thomas, H.R. (1981) *Wet versus dry diets for weaned pigs. Journal of Animal Science*. 52: (1) 14-17.
- Longland, A.C. (1991) *Digestive enzyme activities in pigs and poultry. In vitro digestion for pigs and poultry*. Ed: M.F. Fuller. C A B International, Wallingford, Oxon, UK. pp 3-18.
- Mikkelsen, L.L. and Jensen, B. B (1998) *Effect of fermented liquid feed on the activity and composition of the microbiota in the gut of pigs. 49th Annual meeting of the European Association for Animal Production.. Session 2. Liquid feeding systems in pig production*.
- Partridge, G.G., Fisher, J., Gregory, H., and Prior, S.G. (1992) *Automated wet feeding of weaner pigs versus conventional dry diet feeding: effects on growth rate and food consumption. Animal Production*. 54: 484 (Abstract no. 136)
- Pluske, J.R., Williams, I.H., and Aherne, F.X. (1996). *Maintenance of villous height and crypt depth in piglets by providing continuous nutrition after weaning. Animal Science*. 62: 131-144.
- Russell, P.J. Geary, T.A., Brooks, P.H. and Campbell, A. (1996). *Performance, water use and effluent output of weaner pigs fed ad-libitum with either dry pellets or liquid feed and the role of microbial activity in the liquid feed. Journal of Science Food And Agriculture*. 72: 8-16.

CONTROLLING MANURE VOLUME

**Michael McKeon,
Teagasc, Ballyhaise.**

Introduction

The development of pig production in this country, during the last thirty years, has led to fewer, but bigger, pig units. This increase in pig numbers has resulted in a greater volume of manure being produced, which, in turn, must be spread on land. Growing environmental concern, increased urbanization, and more strict legislation, now means that manure-spreading is becoming more expensive and difficult. Therefore, minimizing the volume of manure produced is becoming very important.

The Cost of Manure

The main cost of manure on a unit is divided between the storage costs, and the land-spreading costs. On most units, manure is stored in concrete tanks underneath slatted-houses. The cost of storing manure in these tanks is at least £22/m³ (£100/1,000 gallons). The spreading cost can vary considerably, due to the distance to the land-spread-area. An estimated cost for land-spreading, within a mile of the unit, is approximately £1/m³ (£4.50/1,000 gallons). This is based on 4,000 gallons of manure being spread per hour, and an agricultural contractor-charge of £18/hour.

The average integrated pig unit in Ireland (344 sows) will produce in the region of 5,332 m³ (1.4 million gallons) of manure per year. If a pig unit could significantly reduce this figure, it would lead to a big financing saving.

Manure Dry Matter

The manure dry-matter reflects the water-content of the manure. The lower the manure dry-matter, the greater the water-content, and larger manure-volume, being produced. This is shown in Table 1, where the figures are based on average feed performance, and an output of 22 pigs sold/sow/year, at 90 kg liveweight.

The aim, therefore, is to minimize the amount of water being used on pig units. This can be done by examining a number of key-areas, such as feeding-systems, dietary-salt, and crude-protein levels, drinker-type, washing-systems, and general maintenance.

Table 1. Manure output per sow per year, at various DM levels

Manure DM %	12	10	8	6	4	2
Volume (m ³)	8.1	9.7	12.2	16.2	24.3	48.7

(Lynch, 1996)

Feeding Systems

The optimum water:feed ratio for grower-finisher pigs decreases as they grow older and heavier. This is reflected in Table 2, which shows recommended water:feed ratios resulting from Dutch research. Ratios in excess of these have little beneficial effect on performance, and lead to greater manure production.

Table 2. Water:feed ratio for pigs of various liveweights

Liveweight	Water:Feed Rratio
25 - 40 kg	2.5 : 1
45 - 70 kg	2.25 : 1
70 kg +	2 : 1

(Centraal Veevoederbureau, 1993)

Wet-dry feeders were developed by the Dutch as a method to reduce water-wastage, and, therefore, minimize manure-production. Research in Holland has shown that wet-dry feeders can reduce the water:meal ratio from 2.5:1.0 to 2.0:1.0, when compared to dry feeders with separate water nipples.

The water:meal ratio in a wet-feed system can have a huge influence on water-usage (Table 3). If you increase the finisher water:meal ratio from 2:1 to 3.5:1.0, in a 320-sow unit, it will increase manure-production by 1,770m³ (470,000 gallons) per year. Many units are basing their water:feed ratio on their pump capacity, rather than the pigs' requirements. Does this make sense? Would it not make more sense for

producers to get a larger pump/reduce the number of bends in their system, instead of storing and spreading unwanted manure at huge cost ?

Table 3. Volume of meat excretion produced by finishing pigs at different water:meal ratios

Water:Meal Ratio (kg/kg)	Volume Meat Excretion (litres/week)
2.0	20
2.5	27
3.0	34
3.5	41
4.0	48

Dietary Salt and Crude-Protein

An increase of salt or crude protein in the diet will increase the voluntary intake of water. Mroz (1995) estimated that an increase in dietary salt of 1g/kg resulted in a higher daily water intake in weaners (0.7 litres), finishers (0.3 litres), pregnant gilts (0.9 litres), and lactating-gilts (0.4 litres). Similarly, the higher the level of crude-protein in the diet, the greater the level of water loss - and hence, more manure produced. A reduction of 1% dietary crude-protein in a weaner diet will decrease manure volume by 0.2 litres/pig (Fullarton and Cullen, 1992).

Drinkers

The flow-rate in drinkers should be sufficient to meet the pigs requirements, but not in excess, as this will lead to wastage. Mroz (1995) stated that excessive water-supply may result in luxury-drinking, and wastage of up to 20%. Recommended flow-rates are shown in Table 4.

Table 4. Drinker-type and flow-rate for different categories of pigs

	Drinker	Flow rate (litres per min.)
Piglets	Bite	0.5
Weaners	Bite	0.5 - 0.8
Finishers	Bite	1.0
Dry Sows and Boar	Bite	2.0
	Nipple	2.5
Lactating Sows	Nipple	3.0

The type of drinker can also influence water-wastage. Research by Barber (1993), and Moorepark, have shown that water-usage dropped by up to 20% when pigs used bite-drinkers, compared to nipple (monoflow) drinkers. Danish research has shown that water-usage could be further reduced (by 15%) when bowl-drinkers are used instead of bite-drinkers.

Washing

Very little research has been done in this area. One study (Roelofs, 1998) did show that soaking finisher pens for 0.5-2.5 hours meant that cleaning took less time, and saved 70 litres of water/pen, when compared to washing unsoaked pens. This study also showed that water-pressure had little effect on water-usage, and turbo-nozzles reduced time and water usage.

Rain-Water

One of the simplest ways to reduce your manure volume is by diverting all rain-water away from manure storage tanks. Most of this rain-water is collected from the unit's roofed-area. This area can vary from 10m² to 11.5m²/sow (including progeny) on an integrated unit. The amount of rainfall collected from the roof-area of an average-size integrated unit (320 sows) is calculated in Table 5. The figures will vary, depending on the location of the unit in the country.

Table 5. The annual volume of roof-rain-water collected from an average unit in different locations in the country

Location	Kerry	Monaghan	Dublin
Annual rainfall (mm)	1,400	920	700
Volume of roof-rain-water collected	4,208.72 m ³ (1,111,829 gallons)	2,731.25 m ³ (721,522 gallons)	2,061.21 m ³ (544,252 gallons)

A pig unit in Kerry can reduce its manure-volume by 4,208m³ (1.1 million gallosn), and save approximately £4,000, by simply piping the rain-water away. Water from roofs and clean yards poses no pollution-risk, and can be piped into the nearest waterway or field.

Maintenance

Leaking overhead-tanks and drinkers are the most common sources of water-wastage on pig units. The amount of water-wastage from a leaking drinker may seem small, but it can add-up to 40 litres/day. Some older buildings may have block-built manure-channels in poor repair. These can allow manure to seep-out, causing pollution problems, or ground-water to seep-in, which will increase your manure volume.

Conclusions

Manure disposal is an increasingly costly problem. The aim of all pig units should be to examine how they can reduce this cost by minimizing manure-volume. This can be done by using the appropriate water:meal ratio, controlling the dietary salt and crude-protein levels, using bite- or bowl-drinkers, soaking pens before washing, and generally minimizing leaks.

References

- Barber, J. (1993). The rationalisation of drinking water supplies for pig housing. PhD Thesis, Plymouth College, Devon.*
- Central Veevoederbureau (1993). In Handbook of Pig Production. The Netherlands.*
- Fullarton, P.J. & Cullen, A. (1992). Dietary manipulation of nitrogen excretion and manure volume from pigs. In Nitrates and Farming Systems, pp. 145-148. Wellesbourne: Association of Applied Biologist.*
- Henry Y (1996). Feeding strategies for pollution control in pig production. In Proceedings of the 14th IPVS Congress, Bologna, Italy 7-10 July 1996.*
- Lynch, P.B. (1996). Prediction of manure composition and output from feed composition. Unpublished.*
- Mroz, Z. & Jongbloed, A.W. (1995). Water in pig nutrition: Allowances and enviromental implications. Nutrition Research Reviews 8, 137-164.*
- Pedersen, B.K. (1994). Water intake and pig performance. Teagasc Pig Conference.*
- Roelofs, P.F. (1993). The influence of soaking procedure, water pressure, water-flow and nozzle on water usage and working time to clean pig houses using a high pressure cleane. In Varkensproefbedrifi "Zuid – en West- Nederland.*

MINIMIZING MANURE ODOUR

**Gerard McCutcheon,
Teagasc, Bagenalstown.**

Introduction

In the U.S., odour from pig production has been described as "the most divisive issue ever in agriculture". In Ireland, complaints to Local Authorities of nuisance odours have increased substantially in recent years. Concern over possible exposure to offensive odour is a common cause of planning-objections to the development of new or expanding pig units. Canadian data indicates that neighbours are significantly more concerned about proposed developments than they are about existing operations, i.e. their fears are based on what might happen in the future rather than on actual problems. Experience with Irish units, in particular those which have been subject to strong planning objections, suggests that operating units are seldom as strong a focus of opposition as planned units.

Emissions from manure are also of concern because of their contribution to greenhouse gases (carbon dioxide, methane, nitrous oxide) which are claimed to contribute to global warming, nitrous oxide (contributor to depletion of stratospheric ozone), or, in the cases of sulphur oxides and ammonia, because they contribute to acid rain. Governments (including Ireland) have promised various international agencies that emission levels of these gases will be cut.

Odour - What Is It ?

What constitutes a bad smell depends on culture, individual taste, and the context in which it is experienced. Age, gender, and personal habits, such as smoking are major influences. Women tend to have a more discriminatory sense of smell than men. Visual cues are important. People expect (and will experience) a bad odour from a dirty farmyard, a dead pig skip, a dirty vacuum tanker, or manure-covered field.

The aerial concentration at which manure odours were found by Carney and Dodd (1989) to be offensive by 50% of panellists was about five times the concentration at which it can be detected by 50% of the population. People tend to be more tolerant of familiar odours than of unfamiliar odours. Persons from an agricultural background, or working with livestock, find odours from livestock operations less offensive. However, in an Arkansas survey, assessors with an association with pig production did not report lower odour scores when evaluating pig units (van Devender, 1997). In Canada, van Kleeck and Bulley (1985) found no difference between neighbours of farm and non-farm backgrounds in their nuisance perception of animal enterprises in the locality, and, in fact, residents of rural origin complained significantly more than did those of urban origin.

Manure Odours

The main source of odour from pig farms is the storage and spreading of manure. Bacterial growth during storage results in release of volatile compounds, which are emitted to the atmosphere from the manure surface and again during agitation and spreading.

Over 168 chemicals have been identified in the air in an animal house, but as few as 15 can cause a range of odours from manures. Many of the compounds with the strongest and most objectionable odours result from the decomposition of surplus protein in the diet.

Odour Control Measures

Manure odours may be reduced by preventing their production and by preventing their emission. Several odour-control techniques used in industry are technically feasible for use in pig production, but are prohibitively expensive. The following methods of odour-reduction are most important for pig producers:

- (a) **Site selection:** For new units, site selection should be downwind, down-slope, and sufficiently remote from neighbours. The use of shelter-belts around pig units to screen the site should be considered. The EPA recommend that new units to be sited a distance of probably not less than 400 m from neighbours. Melvin (1996) recommended that producers aim to keep odour exposure from neighbouring residences to less than 160-170 hours per year (=2% of the time).
- (b) **Good relations with neighbours:** Perception of odours is very subjective, with a strong psychological influence. Reactions to manure odours can be very emotive. Pig producers, and those spreading manure, should be extremely cautious to avoid offending their neighbours. It is much easier to maintain local goodwill than it is to placate an irate community. An individual who is perceived to be a responsible and caring neighbour will have far fewer complaints than somebody whose behaviour is seen to be provocative.
- (c) **Manure storage facilities:** Fully-slatted pens have benefits in cleaner animals and possibly easier disease-control, but result in higher levels of ammonia emissions, and, as a result, part-slatted floors, with steeply-sloping solid areas, are encouraged in the Netherlands. Screening the pig unit and keeping it clean and tidy will help to retain goodwill.
- (d) **Feed formulation:** Many of the odorous compounds produced from manure result from decomposition of protein or nitrogenous compounds in manure. Therefore, the formulation of diets to more closely match the nutritional needs of the animal will result in less nutrients being excreted by animals, and reduce the amount of substrate available to bacteria. More efficient production systems will minimize the feed-usage and manure nutrient output per unit of pigmeat produced.

Using the best available information on "ideal protein" combined with dietary supplementation, Henry (1997) concluded that nitrogen excretion in pig manure could be reduced by 50% over conventional diets. Others have reported significant reductions in several odourants in manure when pigs were fed diets

of lower crude protein content, e.g. a reduction of 10-12.5% in ammonia emissions for each one percent decrease in dietary protein. The low protein diets with added synthetic amino acids supported similar animal performance to high protein diets, but feed prices were not reported. In the Netherlands, phase-feeding, combined with the "optimal housing", reduced ammonia emission by 45%, but the extra cost of the housing was c. £4.0 per pig place per year (van der Peet-Schwering et al., 1996).

Hydrogen sulphide (H_2S , or rotten egg gas) is a highly toxic gas with a strong odour, which is emitted from manure of low pH, when agitated or disturbed. It is one of several sulphur-containing chemicals which have been found in pig manure. Shurson et al. (1999) described the reduction of c. 30% in excretion of sulphur-containing compounds by the formulation of pig diets with low sulphur content. In addition, the emission of H_2S and manure odour intensity were also reduced. Anecdotal evidence from the EPA suggests that pig units, where whey is fed, have a more intense odour than other units, which is consistent with the fact that milk products are particularly rich in sulphur-containing amino acids.

(e) **Manure-spreading-methods:** Emission of ammonia during and following manure-spreading has been extensively researched in Europe, and, in addition to the potential for odour-nuisance, spreading is important for two other reasons, namely: that aerial ammonia contributes to acid rain, and loss of valuable fertilizer nitrogen. Up to 90% of the ammonia losses occur in the first 12 hours after spreading. Burton (1997) said that control of ammonia emission is based on three principles:

1. Reduction in contact-area between liquid manure and the atmosphere (soil injection, band-spreading, ploughing, or harrowing of land).
2. Dilution of manure, which leads to more rapid penetration of manure into soil, also reduces scorch-damage to foliage, but the greater volume increases handling-costs.
3. Acidification of manure.

He showed reductions in ammonia emissions of 40% for a trailing-hose, and 98% for deep-injection, compared with a splash-plate tanker. Reductions in odour may be less than reductions in ammonia emissions.

Dilution of manure with water, before spreading, will reduce emissions, allow more rapid soil-penetration, reduce scorching of foliage, and result in improved utilization of nitrogen, but increases handling costs substantially. In Ireland, O'Connell-Motherway et al. (1997) reported more efficient utilization of N from pig manure when water was added prior to spreading. Carton et al. (1996) reported that the efficiency of utilization of N (in comparison with fertilizer nitrogen) in cattle-manure was improved by reducing the pH to 5.5 with nitric acid. The improvement was from 37% utilization to 81% utilization, where a splash-plate was used, and from 59 to 85% where a band-spreader was used.

Following spreading of manure on arable land, Pain et al. (1991) compared three incorporation methods (plough, rotary harrow, and rigid harrow), applied 0, 3, or 6 hours after spreading. Only ploughing immediately after spreading gave any worthwhile odour-control - a reduction of 52% compared with a reduction of 20% for the rotary harrow.

Dodd et al. (1991) showed that band-spreading of pig manure was very effective in reducing the intensity of odour, especially at moderate distances from the odour-source (Table 1). At 50 metres, the odour from the splash-plate was twice as intense; at 100 metres, the odour from the splash-plate was c.15 times as intense. This evidence strongly supports the use of band-spreading.

(f) Storage of dead pigs: Carcasses of dead pigs should be stored in sealed containers in order to reduce any odours on the site and exclude vermin.

Table 1. Effect of pig manure spreading-method on odour-intensity (in odour units) at various distances

<i>Distance (m)</i>	<i>0</i>	<i>50</i>	<i>100</i>
<i>Splash-plate</i>	<i>170+</i>	<i>31</i>	<i>15</i>
<i>Band-spreader</i>	<i>170</i>	<i>15</i>	<i>1</i>

Conclusions

Odour is becoming more of an issue than it was in the past. It should not be ignored, and there are many ways by which its impact may be reduced. Reaction to odour-exposure is a complex mix of visual, physiological, and psychological factors. Good relations with neighbours, keeping a tidy unobtrusive unit, and a common sense approach to potential complaints, are the critical factors in maintaining good relationships with neighbours.

Following the simple guidelines shown in Appendix 1, during spreading, will go a long way towards preventing problems.

APPENDIX 1

Keys to Minimizing Odour-nuisance from Manure-spreading

- *Direct manure downwards towards the soil, using a band-spreader or a low trajectory splash-plate.*
- *Switch-off the vacuum pump immediately the tanker empties, to minimize mist production*
- *Avoid using rain-guns*
- *Avoid spreading when the wind-direction is toward population-centres or neighbours' houses*
- *Avoid spreading at times when the risk of causing odour-nuisance to the public is greatest, e.g. week-ends, and public-holidays*
- *Spreading in damp or light rain-conditions will minimize smell-drift*
- *Where manure is spread on tilled-soil, or land which is to be ploughed, it should be incorporated into the soil as quickly as possible following application*
- *Notify neighbours when you intend to spread*
- *Avoid spreading near the same neighbours' houses more than once or twice per year*
- *Keep well-back from all dwellings*
- *Cease work upon receipt of a reasonable complaint*

(Adapted from 'Teagasc Code of Practice for Spreading of Slurry' (Carton et al., 1991).

References

- Burton, C.H. (1997). *Manure Management - Treatment Strategies for Sustainable Agriculture*. Silsoe Research Institute, Bedford, UK. 181 pp.
- Carney, P.G. and Dodd, V.A. (1989). *The measurements of agricultural malodours*. *Journal of Agricultural Engineering Research* 43:197-209.
- Carton, O.T., Stevens, R.J., Laughlin, R.J., O'Bric, C.J. and Lenehan, J.J. (1996). *The effect of cattle slurry acidified with nitric acid on nitrogen efficiency for grass silage production*. *Proceedings EU Concerted Action Workshop, Rennes, France*.
- Carton, O., Sherwood, M. and Power, V. (1991). *Soils: Chemical loading from fertilisers and wastes*. Paper presented to *Environmental Impact Conference: Management, treatment and land spreading of waste*. Teagasc, Johnstown Castle, Wexford. September 11-12.
- Dodd, V.A., Campbell, L., Power, N.J. and Looby, K. (1991). *Aeration of pig manure for odour control*. Paper presented to *Environmental Impact Conference: Management, treatment and land spreading of waste*. Teagasc, Johnstown Castle, Wexford. September 11-12.
- Henry, Y. (1997). *Feeding strategies for pollution control in pig production*. In: *Proceedings of the International Pig Veterinary Association Meeting, Bologna, Italy*. pp.45-50.
- Melvin, S. W. (1996). *Swine odor measurement and control issues reviewed*. *Feedstuffs (May 27)*: 12-14.
- O'Connell-Motherway, S., Carton, O.T., Lynch, P.B., O'Toole, P. and Cuddihy, A. (1997). *Effect of pig manure dilution with water and manure application method on the ammonium nitrogen efficiency for a second cut silage crop*. *Proceedings Agricultural Research Forum, University College, Dublin*. pp. 79-80.
- Pain, B.F., Phillips, V.R., Huijsmans, J.G.M. and Klarenbeek, J.V. (1991). *Anglo-Dutch experiments on odour and ammonia emissions following the spreading of piggery wastes on arable land*. *Research Report 91-9, IMAG, Wageningen, Netherlands*, 28pp.
- Shurson, J., Whitney, M. and Nicolai, R. (1999). *Manipulating diets may reduce hydrogen sulfide emissions*. *Feedstuffs (Jan 25)*:12-17.
- van der Peet-Schwering, C.M.C., Verdoes, N., Voermans, M.P. and Beelen, G.M. (1996). *Effect of feeding and housing on the ammonia emission of growing and finishing pig facilities*. *Proefstation voor de Varkenshouderij, Rosmalen. Proefverslag Nummer P 1.145*, 40pp.
- van Devender, K. (1997). *Arkansas Swine Odor Survey*. *Dept. of Agricultural Engineering, University of Arkansas, Little Rock, AR*. 15pp.
- Van Kleeck, R.J. and Bulley, N.R. (1985). *An assessment of separation distance as a tool for reducing farm/neighbor conflict*. In: *Agricultural Waste Utilization and Management. Proceedings of the Fifth International Symposium on Agricultural Wastes*. *American Society of Agricultural Engineers, St. Joseph, Michigan*. Pp. 446-453.

PLANNING AND MANAGING PIG FLOW

**Michael Martin,
Teagasc, Athenry.**

Introduction

Modern pig units will, usually, be designed to operate on an 'All-In, All-Out' basis throughout the different stages of production. However, most Irish pig units have been expanded to their present size in a series of phased developments which may result in less than ideal pig flow arrangements.

Even with a well-designed layout, there are many factors which influence pig flow, and are likely to impact negatively on pig performance. There is a significant gap between average pig performance on units and the potential performance of these pigs. Improved management of pig flow could help to improve unit performance significantly.

Pig Performance

In 1998, pigs between weaning and 90kg liveweight on Irish farms grew, on average, at 596g per day, with a Food Conversion of 2.40. These figures are significantly poorer than those pigs in the Pig Breed evaluation Project at Moorepark (Table 1, Lynch, 1998).

Table 1. Pig performance, weaning to sale

	Commercial Pig Herds - 1998	Pig Breed Evaluation Project
Daily Feed Intake (g)	1432	1486
Average Daily Gain (g)	596	681
Food Conversion	2.40	2.18
Average Liveweight Sale (kg)	90	95

Despite being taken to a 5kg heavier sale-weight, the pigs in the Pig Breed Evaluation Project used 0.22kg less feed (9.2%) to produce 1kg liveweight-gain, and grew at 85g

(14.3%) faster per day. These are very large differences, estimated at £5.01 per pig (Table 2). Despite selling pigs at only 90kg liveweight, the commercial herds would still require an extra 7.7% weaner + finisher accommodation to compensate for these lower growth-rates.

Table 2. Financial benefits of improved growth-rate and FCE (from Table 1)

Liveweight at Sale (kg)	90	95
Kill-Out (%)	75.5	75.75
Deadweight (kg)	67.95	71.96
Pig Value @ 95p/kg (£)	64.55	68.36
Feed Cost per Pig @ £160 per tonne average (£)	<u>40.86</u>	<u>39.66</u>
Margin Over Feed per Pig (£)	23.69	28.70

The failure of pigs on many farms to maximize growth-rate and feed-efficiency may be due, in part, to an inferior health-status and to lower genetic potential. Feed quality may, at times, and, on some farms, be a limiting factor. However, the effect of management factors concerned with organizing pig flow, is also significant.

Factors

A number of factors have to be taken into consideration in planning and organizing pig flow. The following are amongst the most important factors:

- (a) Operate rooms on an 'All-In, All-Out' basis
- (b) Minimize mixing and re-grouping
- (c) Provide pens of optimum size
- (d) Ensure adequate pen-floor-area
- (e) Ensure that access to feed or water is not restricted
- (f) Variation in the performance of individual pigs within a group
- (g) Week-to-week variation in pig output
- (h) Amount of available accommodation

'All-In, All-Out'

An 'All-In, All-Out' (AIAO) system is advocated because:

- (a) *New, younger, pigs entering the room do not share the same air-space with older, and very likely, less healthy pigs. This helps considerably to reduce disease-spread from the older to the younger pigs. This is important in controlling, not alone production-diseases, such as Dysentery or Pneumonia, but also Salmonella.*
- (b) *Rooms can be thoroughly power-washed, disinfected, and rested, if necessary, between one group of pigs being removed and the next group being moved-in. The benefit of trying to wash and disinfect rooms that are partially occupied is in doubt.*
- (c) *Room environment can be regulated more precisely to suit the age/weight of the pigs in the room.*

Mixing / Re-grouping

Within a pen or group of pigs, a social or "peck" order is established following a series of pig-to-pig combats. From each of these combats, one pig emerges as the conqueror and the other as the conquered. The greater the number of such combats-won, the higher is the social rank of the pig within the group.

Mixing and re-grouping pigs can have a profound short-term effect on performance (Table 3). Young pigs show less adverse effects on performance from mixing, when measured over a 3-4 week period. However, with older pigs, research has shown that they were unable to compensate within a 2-week period for the decreased performance caused by re-grouping. In this trial, the pigs were re-grouped at the start, and again after 2 weeks.

Table 3. Effect of re-grouping pigs on performance, over 4 weeks

	<i>Static</i>	<i>Re-group</i>
<i>Daily Feed Intake (kg)</i>	1.99	1.89
<i>Average Daily Gain (g)</i>	752	680
<i>Food Conversion</i>	2.65	2.78

The mixing of pigs is a necessary evil that should be confined as far as possible to younger pigs (weaners), and avoided with older pigs (finishers).

Group / Pen Size

Within a group or pen, a pig appears to be able to recognize about 30 other pigs. This means that with this number, or fewer pigs, a stable social order can be maintained. Above this number, instability can be expected, as pigs continue to interact with one another to re-establish their positions in the social or peck order.

With a smaller group size (<30), the lower-ranking pigs will not be bullied, provided they do not violate the space of more-dominant individuals. However, research has tended to show a deterioration in pig performance as pen size is increased, when the pigs were on restricted feeding. With ad-libitum feeding, a larger group size may not be a problem. Any slight deterioration in pig performance, with larger groups, may be offset by reduced housing-costs.

Most units operate with finisher pens of 15-20 pigs. The actual group size itself is likely to be less important than factors, such as floor area and feeding space per pig, in influencing pig performance.

The size of pens at the different stages of production, and how these are matched, will determine the amount of mixing and re-grouping of pigs required to maximize utilization of space. Small pens (e.g. 10) for First-Stage weaners ensure that pigs from different pens will have to be mixed at a later stage.

Floor Space

The minimum unobstructed floor area for pigs of different weights is set down in legislation (S1 91 of 1995) (Table 4).

Table 4. Minimum floor area per pig

Pig Weight (kg)	Area (m²)	(ft²)
<10	0.15	(1.6)
10-20	0.2	(2.15)
20-30	0.3	(3.2)
30-50	0.4	(4.3)
50-85	0.55	(5.9)
85-110	0.65	(7.0)

Increasing stocking-rates consistently shows a reduction in Growth-Rate, usually in response to reduced Daily Feed Intake (Table 5).

Table 5. Performance response of pigs to increased floor space allocation

Floor Space per Pig				
At 85 kg (m ²)	0.47	0.53	0.59	0.67
(ft ²)	5.0	5.7	6.3	7.2
Daily Feed Intake (kg)f	2.30	2.22	2.30	2.29
Average Daily Gain (g)	844	862	883	897
Food Conversion	2.70	2.56	2.60	2.59
Average Daily Gain Last 28 Days	844	2.56	884	924

Edward et al., 1988

Feeding Space

At least 4 different feeding-methods for weaners and finishers can be identified:

(a) Long Trough / Wet Feeding

Pigs are fed up to 5 or more times per day. At each feed, all pigs can eat together. At the end of the period in the pens, the pigs are likely to be packed together shoulder-to-shoulder. The minimum space required per pig is the shoulder-width of the pig (Table 6). It is also possible that modern and meatier pigs have greater shoulder-widths than pigs 10-15 years ago.

An observation of raised troughs in operation would suggest that these recommendations may be too low, and should be increased by 10% at least.

(b) Feed Hoppers / Dry Feeding

These guidelines are based on 4 pigs per feeding space (Table 6).

Table 6. Pig shoulder width and feeding space

Liveweight (kg)	Shoulder Width (mm)	Trough Space (mm)	Feeder Space (Ad-Lib) (mm)
20	174	175	44
40	220	220	55
90	287	285	71

English et al., 1988

(c) Wet / Dry Feeders

The normal recommendation is a maximum of 15 pigs per feeder. When Walker et al. (1993) compared 10, 20, or 30 pigs, per single space feeder, FCE was 10% worse with 20 or 30 pigs per feeder, but there was no difference in growth-rates (Table 7).

Table 7. Effect of number of pigs per single-space feeder

Number of Pigs per Feeder	10	20	30
Daily Feed Intake (kg)	2.18	2.34	2.31
Average Daily Gain (g)	811	797	807
FCE	2.70	2.93	2.87

(d) Probe Feeding

Feeding is virtually ad-libitum, but there is some aggression when feed is dispensed into the feed trough. Typically, a 1.2m (4 ft) trough is provided for 15-20 finishers.

Growth-Rate Variation

The variation in growth-rate between individual pigs within a group creates a major challenge in organizing pig flow. Slow-growing pigs are likely to be pigs low down in the social order, and are, therefore, more severely affected by poor management conditions. The greater the proportion of the group which are affected, and the more each individual is affected, the greater is the effect on overall group performance. Within a group, a number of pigs may be performing close to their potential. It is the

percentage of the group which are not doing-so, and by how much, that reduces the overall average.

The figures in Table 8 are for growth-rate 10% above and below a moderate growth-rate of 600g per day. In practice, individual pigs may well grow much more slowly than 540g per day.

Table 8. Variation in pig sale weights due to differences in growth-rate

ADG Weaning to Sale (g)	660	600	540
<i>Weight Gain over 140 Days</i>			
<i>Growing/Finishing Period (kg)</i>	92.4	84.0	75.6
<i>Sale Weight at 166 Days</i>	98.9	90.5	82.1
<i>Pigs Weaned at 26 Days and 6.5 Kg</i>			

Improving pig performance and flow requires that the factors which contribute to these low growth-rates are identified and corrected.

Reducing variation in pig growth-rates will contribute significantly to reducing the variation in weight within the pen when the pigs become fit for sale. This would enable pens to be emptied, ideally in one operation (Table 9). This difference of 26kg, over a 140-day (20-week) growing-finishing period, represents a difference of 185g per day in growth-rate.

Table 9. Estimated liveweight range to meet a target carcass weight range

	Minimum	Maximum
<i>Carcass Weight (kg)</i>	55	80
<i>Kill-Out Assumed %</i>	72.5 (a)	78.5 (b)
<i>Liveweight (kg)</i>	76	102

(a) Light entire male

(b) Heavy female

Grouping

When grouping pigs together, it is important to minimize the weight-range within the group. Dutch research has shown that pigs which are kept in a pen, with a small difference in initial weight, had a higher growth-rate and better FCE than pigs kept in a pen with a wide difference in weight (Table 10).

Table 10. Effect of grouping pigs by weight or by age on performance

Range	Weight (kg)		Age (Days)	
	Small (≤ 4.5)	Large (≥ 9)	Small (≤ 7)	Large (≥ 14)
Start Weight (kg)	24.2	24.3	24.3	24.2
Final Weight (kg)	111.5	109.8	111.0	110.2
Daily Feed Intake (kg)	2.18	2.16	2.18	2.16
Average Daily Gain (g)	768	750	764	753
FCE	2.84	2.88	2.85	2.87

van de Loo, et al., 1997

The financial benefit of grouping pigs on the basis of age was considerably less than for grading on the basis of weight.

Production Per Week

Pig units usually operate to a weekly routine. Consequently, weekly production targets are appropriate.

The number of pigs produced in a week is determined by several variable factors.

- (a) Number of sows / gilts served to farrow in the week
- (b) Farrowing Rate
- (c) Litter Size
- (d) Piglet Mortality
- (e) Weaner Mortality
- (f) Finisher Mortality

The average herd produces 42.5 pigs per week per 100 sows (22.2 pigs per sow per year). However, actual production for a herd in a week can fluctuate quite widely. This variation is most likely to be due to variation in the number of sows farrowed per week. In particular, the number of sows/gilts served per week is the crucial factor in determining the farrowing pattern on the unit. Units must target to achieve the required number of farrowings each week (Table 11).

Table 11. Weekly service target per 100 sows

<i>Litters per Sow per Year</i>	<i>Farrowing Rate (%)</i>		
	<i>80</i>	<i>85</i>	<i>90</i>
	<i>Number Served per Week</i>		
2.35	5.65	5.30	5.00
2.40	5.77	5.43	5.13

Farrowing Accommodation

On the majority of units, the average weaning-age is 26-27 days. This is associated with a 35-day/5-week turn-around of farrowing pens. Ideally, farrowing accommodation should consist of 5 rooms or set of pens, each of the same size (Table 12)

Table 12. Theoretical optimum herd size for different farrowing-room sizes

<i>Number of Farrowing-Pens per Room</i>	<i>Optimum Herd Size *</i>
<i>(5 Rooms)</i>	
4	88
7	155
10	220
12	265

* 2.35 litters per sow per year

It is not necessary to have all the pens for each week within one room, but it is advisable to have the farrowing accommodation broadly in 5 equal-sized groups to facilitate 'All-In, All-Out' operation.

Weaner and Finisher Accommodation

To establish the minimum amount of weaner and finisher accommodation required, the following must be taken into account (Table 13):

- (a) Sow out per week
- (b) Weaning weight

- (c) Weaner transfer weight
- (d) Weaner growth-rate
- (d) Weaner places occupancy %
- (f) Number of rest days (washing/disinfection)
- (g) Finisher sale weight
- (h) Finisher growth-rate
- (i) Finisher places occupancy %

These calculations are based on average weekly pig output, and do not take account of the variation from week to week.

Table 13. Minimum number of weaner and finisher places per 100 sows

Average Pig Output per Week		42.5 *
<u>Weaners</u>	Weaning wt. (kg)	6.5
	Transfer wt. (kg)	33.0
	Average Daily Gain (g)	470
	Occupancy (%)	95
	Rest days	4
	Number of weaner places	385
<u>Finishers</u>	Sale wt. (kg)	93
	Average Daily Gain (g)	720
	Occupancy (%)	95
	Rest days	2
	Number of finisher places	544

* 22.1 pigs per sow per year

Summary

While it is extremely difficult to operate any unit on an 'All-In, All-Out' basis, it is still possible to minimize the negative impact of pig flow on pig performance. Correct stocking-rates, with adequate feed space, and groups of less than 30 pigs per pen, are recommended. Mixing and re-grouping is necessary, but should be avoided in older pigs, if at all possible.

Target to produce the same number of pigs each week, by achieving the appropriate weekly service-target.

Pig flow is much easier to manage when housing accommodation at the different stages of production is adequate, for the size of herd, and performance levels being achieved.

References

- Edwards S.A., Armsby A.W. and Spechter H.H. Effects of Floor Area Allowance On Performance of Growing Pigs Kept on Fully Slatted Floors. Anim. Prod. 1988 46: 453 – 459*
- English P.R., Fowler V.R., Baxter S and Smith B. (1988). The Growing and Finishing Pig – Improving Efficiency*
- Hyun, Y., Ellis, M., Riskowski, G and Johnson R.W. (1998). Growth Performance of Pigs Subjected to Multiple Concurrent Environmental Stressors. J. Anim Sci. p 721 – 272*
- Lynch P.B. and Allen, P. (1998). Pig Breed Evaluation Programme Final Report. S.I. No. 91 of 1995 European Communities (Welfare of Pigs) Regulations 1999*
- van de Loo DJPM, Hoofs A.I.J. and Swinkels JWGM (1997). Strategies for Stocking Weaned Piglets and Fattening Pigs.*
- Walker N., Donnelly E., McCracken KJ and Morrow A. (1993). Improving Ad Lib Feeding for Pigs*

NUTRITION FOR OPTIMAL PERFORMANCE OF THE FEMALE PIG

**Mike Tokach, Ph.D., Steve Dritz, D.V.M., Ph.D.,
Bob Goodband, Ph.D., and Jim Nelssen, Ph.D.,
Department of Animal Sciences and Industry, Kansas State University**

INTRODUCTION

In this paper, we briefly review nutrition of the lactating and gestating sow. Recommendations are given for determining the amino acid requirements during lactation, and the energy and amino acid requirements during gestation. An ideal feeding pattern during gestation also is proposed.

Lactation

Our understand of the amino acid requirements of lactating sows has improved greatly in recent years. We know that the lysine requirement during lactation is influenced by energy intake. The lysine requirement to minimize muscle-loss and improve subsequent reproductive performance is higher than the requirement for milk production. Amino acids, other than lysine, also are much more important for maximal milk production than previously thought. Each of these areas is addressed in the following sections.

Energy x Protein Interaction

Both amino acid and energy intake are important in influencing lactation and reproductive performance of the lactating sow. The inter-relationship between energy and lysine intake is depicted in Figure 1. At low energy intake (28.3 MJ/d), increasing lysine intake from 9 to 45 g/d had little effect on milk yield (Tokach et al., 1992b). However, as energy intake increased to 71.9 MJ/d, the response to greater lysine intake increased markedly. These results reveal that milk yield is dependent on both lysine and energy intake, because the response to one is contingent on the intake of the other. Thus, energy intake must be considered when making lysine recommendations for lactating sows.

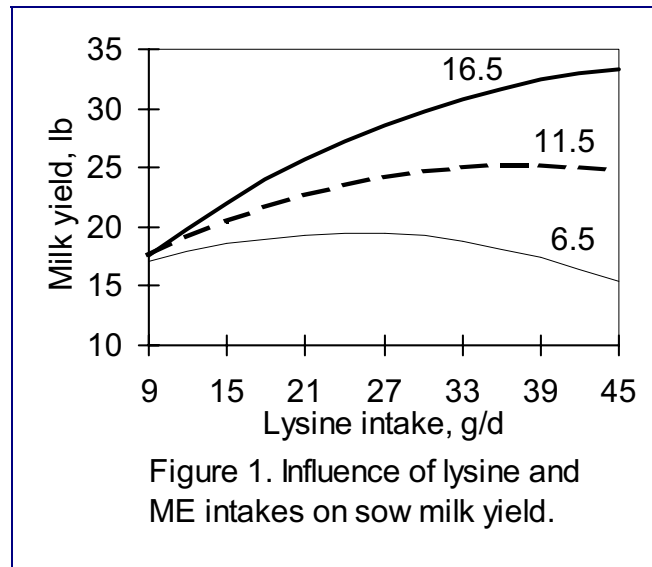

Energy and lysine intake also influence secretion of reproductive hormones and subsequent reproductive performance in an interactive manner (Figure 2; Tokach et al., 1992c). At low energy intake (28.3 MJ ME/d), increasing lysine intake had little influence on mean LH. The influence of lysine intake on LH secretion increased as energy intake increased. These results reveal that LH secretion, similar to milk production, is reduced by restrictions of either lysine or energy intake.

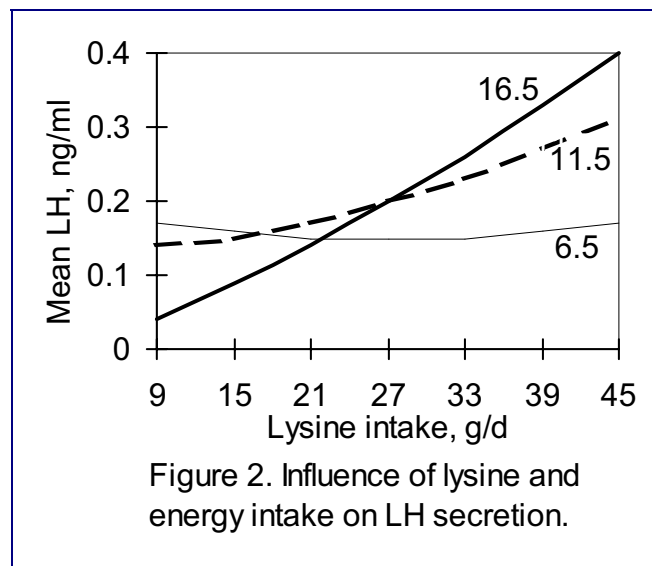

The most practical method of increasing energy intake is to increase total food consumption. The field application of these results is that all steps should be taken to increase total feed consumption during lactation, before attempting to customize dietary lysine levels to a particular swine farm. Trials from the University of Minnesota indicate the impact of lactation feed intake on subsequent reproduction

increases as weaning age is reduced (Koketsu et al., 1996). Use of high dietary fat levels during lactation will improve litter weaning weights, but may actually impair subsequent reproductive performance by reducing the number of LH peaks in early lactation (Kemp et al., 1995). Limiting intake during lactation should **NOT** be practiced.

Feed intake during lactation has been a problem on many farms in the U.S. Weaning age has settled between 16 and 21 days of age for most farms. Feed intake in early lactation is critical with these weaning ages to increase weaning weight to make pigs more manageable in the nursery. Lactation feed intake is also critical with older weaning ages. Light-weight pigs entering the nursery is still an issue, although a smaller issue, but the importance of high energy and amino acid intake for subsequent reproduction is still paramount.

Influence of Lysine Intake on Milk Production

Over the years, lysine is the amino acid which has been most intensely investigated. Research by Schoenherr et al. (1988), Stahly et al. (1990), Johnston et al. (1991), and Tokach et al. (1992b) suggested that the lysine requirement was greater for high-producing sows than previously suggested. In all of these trials, total protein level of the diet was increased, with lysine considered to be the first limiting amino acid. However, every experiment conducted has suggested different requirements for the lactating sow.

The different recommendations from the various experiments are due largely to differences in sow productivity and feed intake. An excellent summary and explanation of the different recommendations for dietary lysine during lactation was presented by Pettigrew (1993). He indicated the driving-factor for the different lysine recommendations is the production-level of the sows. Pettigrew (1993) performed regression analysis on litter growth-rate and lysine-intake from several trials, and determined that 26g of lysine is required for every kilogram of daily litter weight-gain. A daily maintenance requirement (22 mg/lb^{.75} BW, or approximately 2 g/d, of lysine for a 150kg [330lb] sow) should be added to this requirement, while the lysine contributed from tissue-breakdown (approximately 0.1g lysine/kg [0.2g lysine/lb] BW

loss) should be subtracted to provide an estimate of the sow's requirement. Based on expected feed intake, the grams/day requirement can be converted into a dietary percentage. For example, if a 150kg sow weans a litter weighing 61 kg at 21 days, the litter birth-weight was 16kg, and the sow lost 4.5kg during lactation, the sow would require 56g lysine/d (45kg litter gain/21 d = 2.14kg/d; 2.14kg/d x 26g lysine/kg = 56g lysine for litter gain; 56g lysine for litter gain + 2g lysine for maintenance -2g lysine from tissue-breakdown = daily lysine need of 56g).

Several factorial methods also have been used to determine the lysine need of the lactating sow. We used a combination of several methods to assemble Table 1. We use this simple chart to determine initial dietary lysine level for a producer, based upon lactation feed-intake and litter weaning-weight. Lactation feed-intake can be determined from feed intake cards, or past usage of the lactation diet from records. If the previous lactation diet is higher in lysine than the recommended level from the Table, it may be possible to reduce the dietary lysine level without sacrificing performance. If the previous lysine level is lower, or the same as the recommendation, the producer may want to increase the lysine (protein) level and re-examine performance-records to determine whether litter weaning weight increases. This is a relatively simple approach which has worked well for us to customize sow lactation diets.

Table 1. Dietary lysine level based upon litter weaning-weight and sow feed-intake

Litter Weight (kg)		Lactation Feed Intake (kg/day)								Lysine (g/day)
21 d	28 d	3.5	4.0	4.5	5.0	5.5	6.0	6.5	7.0	
45	55	1.05	0.90	0.80	0.70					36
50	61	1.20	1.05	0.95	0.85	0.75				42
55	68		1.20	1.05	0.95	0.85	0.80			48
60	75			1.20	1.10	1.00	0.90	0.85		55
65	81				1.20	1.10	1.00	0.92	0.85	60
70	88					1.20	1.10	1.05	0.95	67

Influence of Lysine Intake during Lactation on Subsequent Reproductive Performance

Once the optimal lysine level for litter weight-gain has been determined, there still remains the question of sow longevity, and the potential influence which lactation feeding may have on subsequent reproduction. This question becomes critical when you consider that the lysine or protein requirement for optimal litter weight-gain is lower than that required to minimize nitrogen-loss and muscle-catabolism during lactation. King et al. (1993) reported that first-litter gilts, nursing nine pigs, required a 1.08% lysine diet (40.5 g/d) to maximize litter growth-rate when feed consumption was 8.3lb (Table 2). However, to minimize nitrogen-loss, a 1.30% lysine diet (48.8 g/d) was required. These results are supported by Touchette et al. (1996) where they demonstrated the lysine requirement for minimizing weight loss (54 g/d) or loin muscle loss (58 g/d) were considerably higher than the amount needed to maximize litter weaning weights.

We must then ask ourselves the question of whether diets should be formulated to maximize litter weight-gain or to minimize nitrogen-loss by the sow. Until recently, evidence directly connecting amino acid intake during lactation and resultant muscle catabolism with reproductive hormone secretion, or subsequent litter size, was lacking. Research shown in Figure 2 by Tokach et al. (1992c) and data from Jones et al. (1995) demonstrate that low amino acid and energy intake during lactation decreases LH secretion. King and Martin (1989) also found that sows experiencing restricted protein intake during lactation have a reduced mean LH concentration, and fail to develop a high LH pulse frequency during lactation. Tokach et al. (1992c) also demonstrated that LH secretion during lactation was related to weaning-to-estrus interval.

Table 2. Effect of dietary lysine intake during lactation on first-parity sows^a

Item	Lysine (%)					
	0.44	0.66	0.87	1.08	1.30	1.51
ADFI (kg/d)	3.8	3.7	3.8	3.8	3.8	3.6
Sow weight-loss (kg)	27.4	23.3	25.3	22.3	23.8	24.5
P1 Backfat-loss (mm ^b)	3.2	5.0	9.2	9.1	9.1	9.3
Litter growth-rate (g/d ^{b,c})	177	191	213	227	213	218
Milk Yield (kg/d)						
Early lactation ^d	7.79	8.02	9.12	8.89	8.39	9.19
Late lactation ^e	7.02	7.40	8.42	8.40	7.76	8.90
Nitrogen Balance (g/d)						
Early lactation ^b	-36.7	-26.2	-23.1	-13.9	-2.5	-6.7
Late lactation ^b	-25.9	-19.8	-16.1	-12.9	-0.2	-6.7

^a King et al., 1993^{b,d,e} Linear effect of lysine ($P < 0.001$; 0.05; 0.01, respectively)^c Quadratic effect of lysine ($P < 0.05$)

Data from Australia has continued to clarify the connection between amino acid intake during lactation and subsequent reproduction. Tritton et al. (1993; as cited in King, 1994) reported that lysine intake during the first lactation period influenced subsequent litter size (Table 3). They found a 1.2 pig increase in the subsequent farrowing when gilts were fed a 1.30% lysine diet during their first lactation compared to diets with lower lysine levels. The optimal lysine level in this research coincides with the lysine level required to minimize negative nitrogen balance from King et al. (1993). This is an interesting finding which may provide insight into the second parity-dip in litter size often seen in swine herds. A study comparing first-parity sows, fed dietary lysine levels of 0.9% or 1.3%, supports the Australian data (Wilson et al., 1996). No differences were found between the treatments in litter weaning weight, but a shorter weaning-to-estrus interval was found for sows fed the higher lysine diet (15.0 days vs. 11.1 days).

Table 3. Influence of dietary lysine on lactation and subsequent reproductive performance in first-litter sows^a

	Protein (%)	14.9	17.1	19.5	22.5	24.9	
Item	Lysine (%)	0.62	0.84	1.06	1.31	1.51	SEM
Feed intake (kg/d)		4.5	4.4	4.2	4.6	4.5	0.6
Lysine (g/d)		28	37	45	61	68	--
Pig weight on d 23 (kg)		5.7	6.3	6.1	6.7	6.2	0.4
Weaning-to-oestrus (days)		8.4	8.2	8.5	8.5	8.7	1.1
Subsequent litter size alive		9.7	9.5	9.8	10.9	10.6	0.5
Subsequent litter size total		10.3	9.8	10.4	11.6	11.0	0.5

^a Adapted from Tritton et al., 1993 (as cited in King, 1994)**Table 4. Lactation feed intake and lysine intake as influenced by parity and dietary lysine level**

	Parity						
Item	1	2	3	4	5	6	7
Lactation feed intake (kg)	4.6	5.2	6.1	5.9	6.4	6.2	6.5
Lysine intake (g/d)							
0.95% lysine diet	43.7	49.6	58.1	56.4	60.3	59.0	61.8
1.1% lysine diet	50.6	57.2	67.1	64.9	70.4	68.2	71.5

In summary, research clearly demonstrates that amino acid intake during lactation can influence subsequent reproduction. However, further research must be conducted to further characterize this relationship and to determine which amino acids are most important in this response. Three recent trials reported at the 1999 American Society of Animal Science meetings concluded that the lysine requirement for lactating sows was approximately 56 g/d. The problem with providing all sows in the herd with a specific level of lysine intake is the impact of parity on feed intake. An example of the distribution in parity and lysine intake for one farm is shown in Table 4. Only one lactation diet is practical on most farms. Thus, parity distribution should be evaluated to determine the most economical approach. Most farms in the U.S. slightly over-formulate the lactation diet for the older sows to more closely meet the requirements of the lower intakes in the first two parities.

Other Amino Acids

Recent research have greatly improved our ability to provide a sow herd with the correct dietary lysine level for gestation and lactation. However, a question remains concerning the appropriate level for other amino acids in the diet. To help answer this question, information regarding the suggested amino acid ratios, suggested by the NRC (1988 and 1998) and ARC (1981), for the lactating sow, are listed in Table 5.

Table 5. ARC and NRC amino acid ratios for lactating sows^{a,b}

Amino Acid	ARC Ratio^c	NRC Ratio	
		1988	1998
Lysine	100	100	100
Histidine	39	42	39
Isoleucine	70	65	56
Leucine	115	80	108
Met & Cys	55	60	48
Phe & Tyr	115	117	111
Threonine	70	72	65
Tryptophan	19	20	18
Valine	70	100	82

^a ARC (1981)

^b NRC (1988 and 1998)

^c Amino acids are listed as a percent of lysine

Research with the other amino acids was summarized by Tokach et al. (1996). Briefly, researchers have demonstrated that the valine requirement (Tokach et al., 1992a; Richert et al., 1994a,b), total branch chain amino acid requirement (Richert et al., 1996), and methionine requirement (Schneider et al., 1992) are much higher than predicted by NRC or ARC. More research is needed with these amino acids, as well as tryptophan and threonine; however, results to-date indicate that these amino acids must be carefully considered in diet formulation to prevent costly limitations during lactation. In practical diet formulation, we formulate to meet the lysine requirement of the sow and attempt to maintain valine, isoleucine, and methionine, as high as possible without incurring excess cost. As more data becomes available, these amino acids may be added as standard ingredients in lactation diets, similar to the use of synthetic amino acids in starter and grow-finish diets.

Gestation

Nutrient requirements during gestation can be divided into three different areas: (1) maintenance, (2) maternal growth, and (3) foetal growth. Basic energy and amino acid requirements can be determined using a factorial approach, as will be demonstrated in the following sections. In addition, the pattern of intake is important due to influences on embryo survival, lactation fed intake, and, in recent literature, subsequent growth and lean deposition of the offspring.

Energy Requirements

Maintenance-needs account for 75 to 80% of the energy requirement during gestation (Table 6). The maintenance energy requirement can be calculated as 0.46 MJ DE/kg⁷⁵. The requirement for maternal growth can be calculated by making assumptions about the composition of the gain, and requirements to attain that composition (i.e. gain, with a composition of 25% fat and 15% protein, would have a requirement of approximately 20.9 MJ DE/kg gain). The developing litter has a very small nutrient requirement and a high priority for nutrients. The requirement for conceptus growth is only about 0.9 MJ DE/day. Using these values, you can easily calculate the energy requirement of sows in a thermoneutral environment. Approximately 50g of feed is required for every degree-celsius below 18°C (0.061lb of feed for every degree-fahrenheit below 64°F).

Table 6. Energy requirement of gestating sows

	115	150	200
Sow weight (kg)			
Weight gain (kg)	30	20	10
	MJ ME/day		
Maintenance	16.63	19.87	24.49
Weight gain	5.49	3.66	1.83
Conceptus	0.90	0.90	0.90
Total required	23.0	24.4	27.2
	Feed/day		
Kilograms	1.65	1.75	1.95
Assumptions	: 14 MJ DE/kg diet		
Maintenance	: 0.462 MJ DE/kg ⁷⁵ (0.462 kcal [13 + 0.2 x live-weight, kg])		
Weight gain	: 20.9 MJ DE/kg gain (25% fat & 15% protein) x weight-gain, kg/114 days		
Conceptus	: 0.9 MJ DE/day		

Excessive energy intake during gestation results in three major problems. The high energy (feed) intake: (1) is unnecessary expense; (2) reduces feed intake during lactation; and (3) impairs mammary development.

Amino Acid Requirements

Similar calculations to those for energy can be made to determine the requirement for protein (Table 7) or individual amino acids during gestation. Detailed estimates for the essential amino acids are provided by Pettigrew (1993). The individual amino acid requirements are influenced greatly by the expected lean-tissue-gain during pregnancy. A mature sow gaining 20kg (44lb) from breeding to farrowing requires less than 9 g/d of lysine, similar to NRC (1988) requirement. Younger gilts bred at 130kg (285lb) with an expected gain of 30kg (66lb) would require 11 g/d of lysine. As the expected weight-gain increases, the lysine need may increase to as high as 14 g/d in some first-parity gilts. However, these levels can be achieved with a relatively low lysine diet (0.55 to 0.70%), depending on the level of feed intake.

Excessive protein intake during gestation unnecessarily increases feed cost. In one trial (Mahan and Mangan, 1975), high protein intake during gestation reduced feed intake during lactation.

Table 7. Protein requirement of gestating sows

Sow weight (kg)	115	150	200
Weight gain (kg)	30	20	10
	Protein (g/day)		
Maintenance	60	79	105
Weight gain	39	26	13
Conceptus	21	21	21
Total required	121	126	139
Required in diet	216	225	248
	Feed/day		
Kilograms	1.60	1.67	1.84

- Assumptions** : 13.5% crude protein and 0.6% lysine in diet
Dietary protein was 56% available (80% digestible and 70% biological value)
- Maintenance (g/day)** : Sow weight (kg) x 0.0525% protein * 1000 g/kg
- Weight gain (g/day)** : 15% protein x weight-gain (g) / 114 days
- Conceptus gain** : 20 kg at 12% protein = 2.4kg; 2.4 kg/114 = 21 g/d
Actual requirement is 13, 26, and 52 g/d, in first, second, and third trimesters

Feed Intake Pattern during Gestation

Energy and protein requirements during gestation were reviewed in the previous sections. High or low feed intake, during particular phases during gestation, can cause deleterious effects, or have specific advantages. Each stage of gestation is discussed below. These stages are depicted in Figure 3 as a proposed ideal feeding pattern.

Day 0 to 30

Several researchers have reported that high intake, before day 30 of gestation, decreased embryo survival. The increased embryo mortality was attributed to a reduction in plasma progesterone concentration, due to increased blood flow and hepatic clearance of progesterone, caused by the high feed intake. Further research (Jindal et al., 1996) indicates the critical window to reduce feed intake to prevent embryo mortality may be during the first 48 to 72 hours after mating. The safest recommendation is to limit feed intake from breeding until day 12 after breeding.

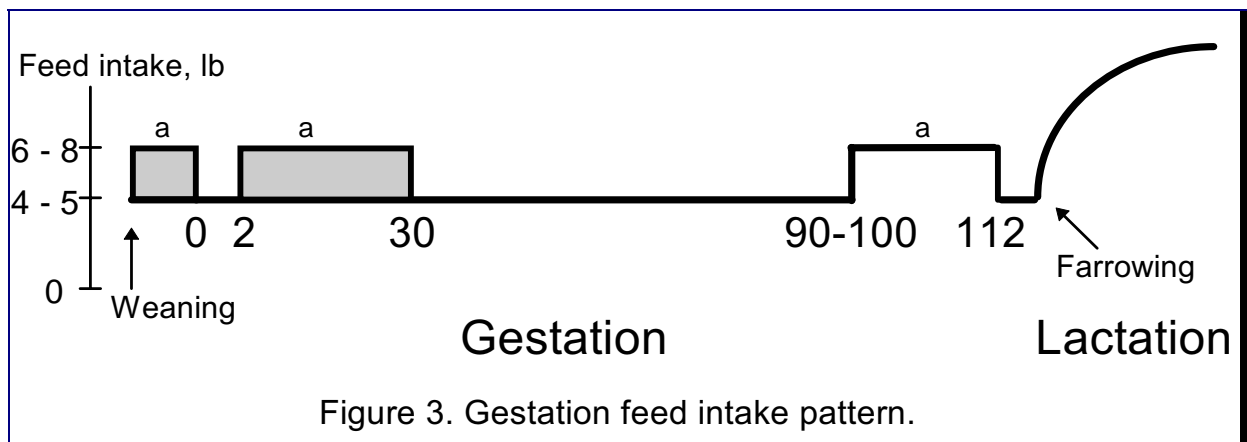

Figure 3. Gestation feed intake pattern.

^a Indicates periods to increase feed intake above the standard intake of approximately 25.5 MJ/day (1.8 kg of a corn-soyabean-meal-based diet) based on sow body condition and expected weight-gain

The body condition or energy state of the sow also influences the response to high levels of feed intake after mating. Embryo mortality is only increased when high levels of feed are provided to sows in good body condition. Embryo mortality was actually reduced by providing extra feed, for the first thirty days after breeding, to sows in poor body condition due to low lactation feed intake. Therefore, feeding according to body condition, during the first 30 days of gestation, is critical for minimizing embryo

mortality. Recent unpublished data from Australia also credits high feeding during early gestation with increasing farrowing rate during the Summer months, when seasonal infertility is a problem.

Feeding level from day 0 to 45 is shown as a shaded-area in Figure 3. The shading indicates the feeding level should be adjusted to match the body condition of the sow. The goal should be to have the sow at the body condition desired for farrowing by day 45 of gestation. In order to reduce the possibility that the higher feed intake will increase embryo mortality, feeding level from day 0 to 12 of gestation is shown at the baseline value (approximately 2kg [4.4lb] of a diet containing 3.2 Mcal ME). Remember, very thin sows should receive a high level of intake immediately after mating until body condition is restored.

Day 30 to 75

Current understanding of this period during gestation is poor. As shown in Figure 3, the general recommendation is to feed a constant level, sufficient to meet the energy requirements of the sow and maintain body condition. However, recent research indicates that this is a critical period for muscle differentiation of the developing foetuses. Sterle et al. (1995) found injections of porcine somatotrophin (pST) between day 30 and 43 increased placental weight and weight of the lightest foetuses. The authors hypothesized that pST increased nutrient uptake and utilization by the foetuses by increasing nutrient transfer across the placenta. In another trial, pST injections from day 28 to 40 increased embryo survival, embryo weight, and specific gene expression for certain muscles (Kelly et al., 1995). Offspring from the sows injected with pST for the specific window of gestation (day 28 to 40) had reduced backfat and heavier trimmed loin weight at market than pigs from the control sows. Dwyer et al. (1994) observed a similar response by doubling feed intake (2.5 vs 5.0 kg/day) from day 25 to 80 of gestation. The high feed intake increased the number of secondary muscle fibres and improved growth-rate and feed-efficiency of the offspring during the growing period (day 70 to 130 of age). As subsequent research identifies the specific nutrient(s) and time-period to elicit the optimal response, stage feeding during gestation, for muscle development of the foetuses may become an important part of commercial swine production.

Day 75 to 100

This period is critical for mammary development. Excessive energy intake during this period increases fat deposits, and reduces the number of secretory cells, DNA, and RNA in the mammary gland (Weldon et al., 1991). The result is lower milk production during lactation. Excess feed intake should be avoided during this time.

Day 100 to 112

Feed intake should be increased by 1 to 2kg (2 to 4lb) from day 100 to 112 of gestation to prevent sows from losing weight during this period of rapid foetal growth. Failure to increase feed intake during this period results in sows in an extremely catabolic state at farrowing. The catabolic state contributes to gorging, and sows "going off feed" during lactation.

Day 112 to 114

Feeding pattern during the last few days of gestation is a controversial area. We prefer to feed 2 kg or more from day 112 to 114. Field-experience indicates that extremely low intake of 1kg or less, during this time, limits the producers' ability to increase feed intake rapidly during early lactation. In extreme cases, ulcers can be created by the extended period of low intake around farrowing. After the long period without feed, sows often over-eat if provided free access to feed. The sows will go off-feed or have a noticeable dip in feed intake. Many people prescribe limit-feeding as a cure for the sows going off-feed, instead of correcting the problem which originally caused the problem (the extended period of little or no feed, prior-to and immediately-after, farrowing).

CONCLUSIONS

Productivity and lactation feed-intake are important determinants for optimizing diet-formulations for lactating-sows. Diets for lactating-sows should be formulated to match the level of feed-intake and sow-productivity (litter weaning-weight). Formulating higher protein diets for first and second-parity sows minimizes nitrogen-loss and improves subsequent reproductive performance. When formulating diets for

lactating sows, care should be taken to avoid deficiencies in amino acids other than lysine (valine, isoleucine, methionine). Nutrient requirements during gestation are small, but the feed-intake pattern can influence reproductive performance. Staged-feeding is important to meet the specific goals of each period during gestation. Timing, as well as quantity of nutrients fed during each gestation period, is important for optimizing subsequent lactating and reproductive performance.

References

- ARC. 1981. *The Nutrient Requirements of Pigs*. Commonwealth Agricultural Bureaus, Slough, UK.
- Baltranena, E., G. R. Foxcroft, F. X. Aherne, and R. N. Kirkwood. 1991. Endocrinology of nutritional flushing in gilts. *Can. J. Anim. Sci.* 71:1063.
- Boomgaard, J., D. H. Baker, A. H. Jensen, and B. G. Harmon. 1972. Effect of dietary lysine levels on 21-day lactation performance of first-litter sows. *J. Anim. Sci.* 34:408.
- Chen, S. Y., J. P. F. D'Mello, F. W. H. Elsley, and A. G. Taylor. 1978. Effect of dietary lysine levels on performance, nitrogen metabolism and plasma amino acid concentrations of lactating sows. *Anim. Prod.* 27:331.
- Dwyer, C.M., N.C. Stickland, and J.M. Fletcher. 1994. The influence of maternal nutrition on muscle fiber number development in the porcine fetus and on subsequent postnatal growth. *J. Anim. Sci.* 72:911.
- Jindal, R., J. R. Cosgrove, F. X. Aherne, and G. R. Foxcroft. 1996. Effect of nutrition on embryo mortality in gilts: association with progesterone. *J. Anim. Sci.* 74:620.
- Johnston, L. J., J. E. Pettigrew, and J. W. Rust. 1991. Response of maternal-line sows to dietary protein concentration during lactation. *J. Anim. Sci.* 69(Suppl. 1):118(Abstr.).
- Jones, D. B., and T. S. Stahly. 1994. Impact of amino acid nutrition during lactation on subsequent reproductive function of sows. Iowa State Univ. 1994 Swine Res. Rep. pp 56.
- Kelley, R.L., S. B. Jungst, W. F. Owsley, D. D. Wolfe, T. A. Powe, W. B. Mikel, C. H. Rahe, and D. R. Mulvaney. 1995. Possible use of pST administration to gestating gilts to alter gene expression in fetal muscle, enhance postnatal growth and carcass characteristics of progeny. *J. Anim. Sci.* 73:.
- Kemp, B., N. M. Soede, F. A. Helmond, and M. W. Bosch. 1995. Effects of energy source in the diet on reproductive hormones and insulin during lactation and subsequent estrus in multiparous sows. *J. Anim. Sci.* 73:3022.
- King, R. H., and G. B. Martin. 1989. Relationships between protein intake during lactation, LH levels and oestrus activity in first-litter sows. *Anim. Reprod. Sci.* 19:283.
- King, R. H., M. S. Toner, H. Dove, C. S. Atwood, and W. G. Brown. 1993. The response of first-litter sows to dietary protein level during lactation. *J. Anim. Sci.* 71:2457.
- Koketsu, Y., G. D. Dial, and V. L. King. 1996. Factors influencing farrowing rate on farms using early weaning. *J. Anim. Sci.* 74(Suppl. 1):31(Abstr.).
- Lewis, A. J. and V. C. Speer. 1973. Lysine requirement of the lactating sow. *J. Anim. Sci.* 37:104.
- Mahan, D. C., and L. T. Mangan. 1975. Evaluation of various protein sequences on the nutritional carry-over from gestation to lactation with first-litter sows. *J. Nutr.* 105:1291.
- Nissen, S., T. D. Faidley, D. R. Zimmerman, R. Izard, and C. T. Fisher. 1994. Colostral milk fat percentage and pig performance are enhanced by feeding the leucine metabolite β -hydroxy- β -methyl butyrate to sows. *J. Anim. Sci.* 72:2331.
- NRC. 1988. *Nutrient Requirements of Swine*. Ninth Revised Edition. National Academy Press, Washington, DC.
- O'Grady, J. F. and T. J. Hanrahan. 1975. Influence of protein level and amino-acid supplementation of diets fed in lactation on the performance of sows and their litters. 1. Sow and litter performance. *Irish J. Agric. Res.* 14:127.
- Pettigrew, J. E. 1993. *Biokyowa Nutrition Update*. Lactation requirements for the sow.

- Richert, B. T., R. D. Goodband, M. D. Tokach, and J. L. Nelssen. 1996. Increasing dietary valine and isoleucine for the high producing lactating sow. *J. Anim. Sci.* 74(Suppl. 1):63(Abstr.).
- Richert, B. T., R. D. Goodband, M. D. Tokach, J. L. Nelssen, R. G. Campbell, S. Kershaw, and S. A. Blum. 1994a. The effect of lysine and valine fed during lactation on sow and litter lactation performance. *Kansas State University Swine Day 1994*, pp 15.
- Richert, B. T., M. D. Tokach, R. D. Goodband, J. L. Nelssen, J. E. Pettigrew, R. D. Walker, L. J. Johnston, and S. A. Blum. 1994b. *Kansas State University Swine Day 1994*, pp 10.
- Schneider, R., M. Kirchgessner, F. J. Schwarz, and B. R. Paulicks. 1992. Futteraufnahme und lebendmasseentwicklung von sauen wahrend der laktation in abhangigkeit von der methioninversorgung. I. mitteilung zum bedarflaktierender sauen an schwefelhaltigen aminosauern. *J. Anim. Phys. Anim. Nutr.* 68:235.
- Schoenherr, W. D. 1988. Feeding strategy for the high-producing lactating sow. 49th Minnesota Nutrition Conference and Degussa Technical Symposium. Minnesota Extension Service, Bloomington, Minnesota.
- Stahly, T. S., G. L. Cromwell, and H. J. Monegue. 1990. Lactational responses of sows nursing large litters to dietary lysine levels. *J. Anim. Sci.* 68(Suppl. 1):369(Abstr.).
- Sterle, J. A., T. C. Cantley, W. R. Lamberson, M. C. Lucy, D. E. Gerrard, R. L. Matteri, and B. N. Day. 1995. Effects of recombinant porcine somatotropin on placental size, fetal growth, and IGF-I and IGF-II concentrations in pigs. *J. Anim. Sci.* 73:2980.
- Tokach, M. D., R. D. Goodband, and J. L. Nelssen. 1993. Valine: a limiting amino acid for high producing sows. *Kansas Agric. Exp. Sta. Rep. of Prog. No.* 695 p.5.
- Tokach, M. D., R. D. Goodband, J. L. Nelssen, J. L. Laurin and J. A. Hansen. 1992a. The effects of an ideal protein lactation diet on sow and litter performance. *J. Anim. Sci.* 70(Suppl. 1):69(Abstr.).
- Tokach, M. D., J. E. Pettigrew, B. A. Crooker, G. D. Dial, and A. F. Sower. 1992b. Quantitative influence of lysine and energy intake on yield of milk components in the primiparous sow. *J. Anim. Sci.* 70:1864.
- Tokach, M. D., J. E. Pettigrew, G. D. Dial, J. E. Wheaton, B. A. Crooker, and L. J. Johnston. 1992c. Characterization of luteinizing hormone secretion in the primiparous, lactation sow: relationship to blood metabolites and return-to-estrus interval. *J. Anim. Sci.* 70:2195.
- Tokach, M. D., B. T. Richert, R. D. Goodband, and J. L. Nelssen. 1996. Amino acid requirements for lactating sows: New developments. *Compendium.* 18:S127
- Tritton, S. M., R. H. King, R. H. Campbell, and A. C. King. 1993. Manipulating Pig Production IV. Australasian Pig Science Association, Werribee, Australia (As cited in King, R. H. 1994. Feeding gilts and sows of the new genotypes to optimize reproductive performance. North Carolina Pork Producers Conference, Fayetteville, NC January 11 to 12, 1994.
- Touchette, K.J., G. L. Allee, M. D. Newcomb, K. M. Halpin, and R. D. Boyd. 1996. Lysine requirement of the lactating primiparous sow. *J. Anim. Sci.* 74(Suppl. 1):63(Abstr.).
- Weldon, W. C., O. A. Thulin, L. J. Johnston, E. R. Miller, and H. A. Tucker. 1991. Effect of increased dietary energy and protein during late gestation on mammary development in gilts. *J. Anim. Sci.* 69:194.
- Wilson, M. E., H. Stein, N. L. Trottier, D. D. Hall, R. L. Moser, D. E. Orr, and R. A. Easter. 1996. Effects of lysine intake on reproductive performance in first parity sows. *J. Anim. Sci.* 74(Suppl. 1):63(Abstr.).